

A

S641-WKSZF

ANGA

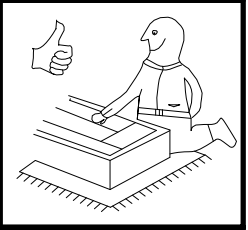
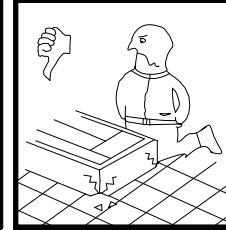
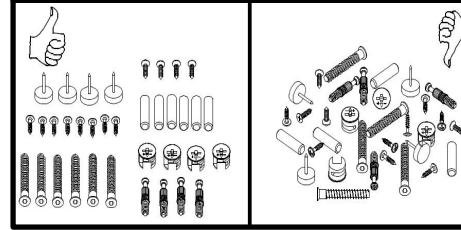

L



R

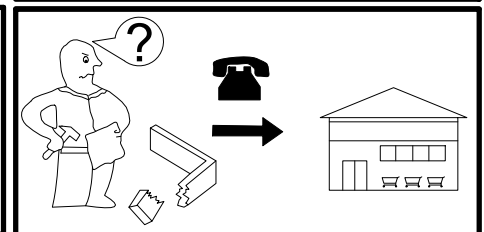
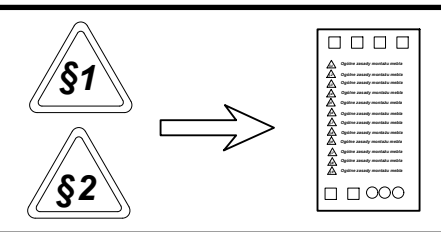
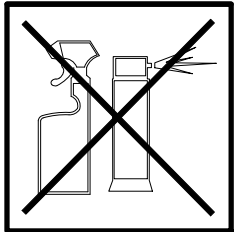
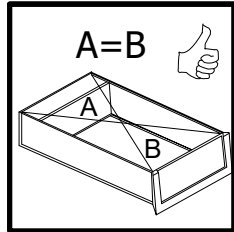
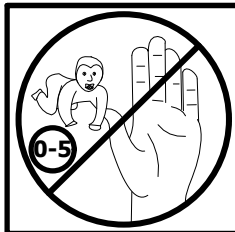
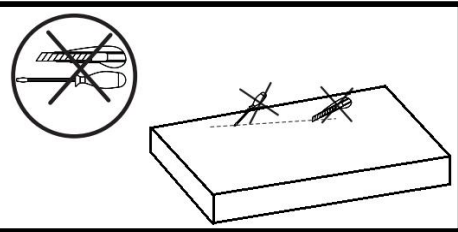
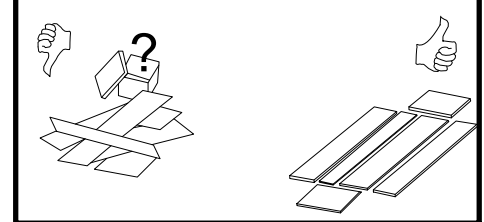
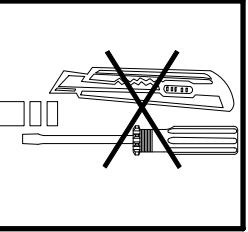
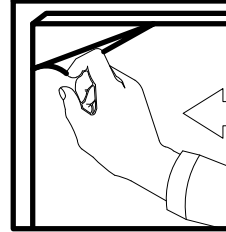
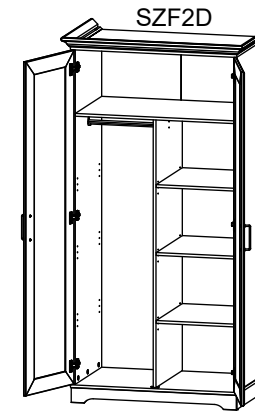
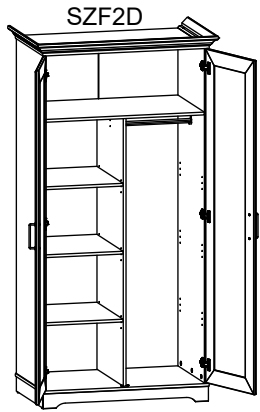
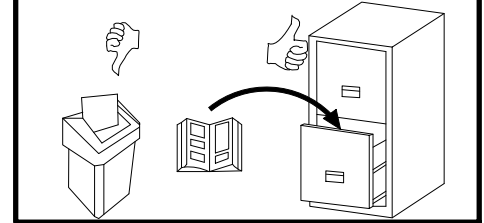
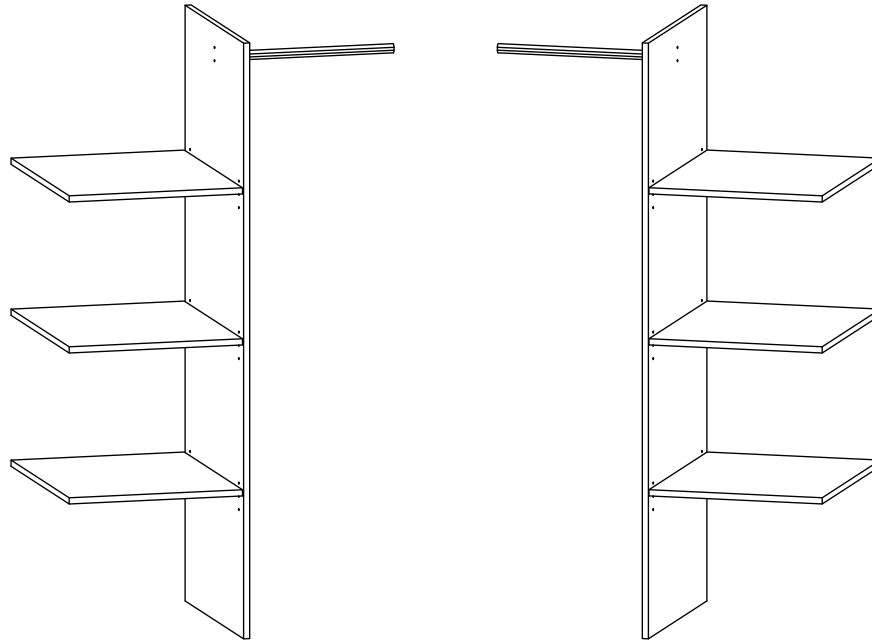

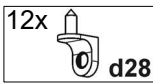
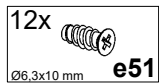
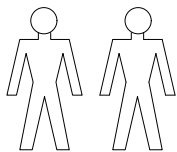

A	B1	B2	C1	C2	C3	D
1	S641-1018	-	1440	538	15	1/1
2	S641-3007	-	427	535	15	1/1
3	dr-420		420	22	15	1/1

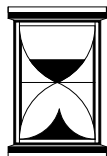
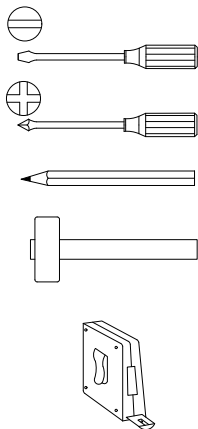

20 min

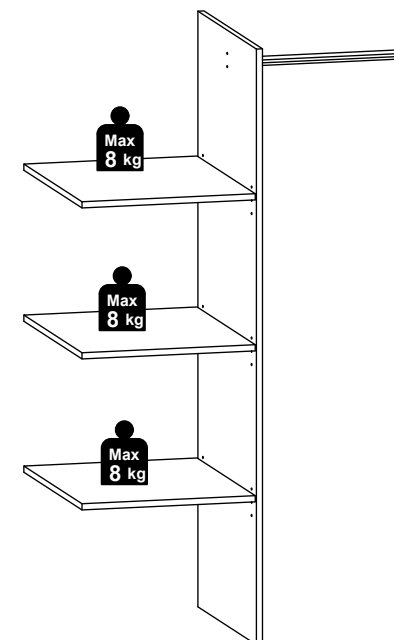
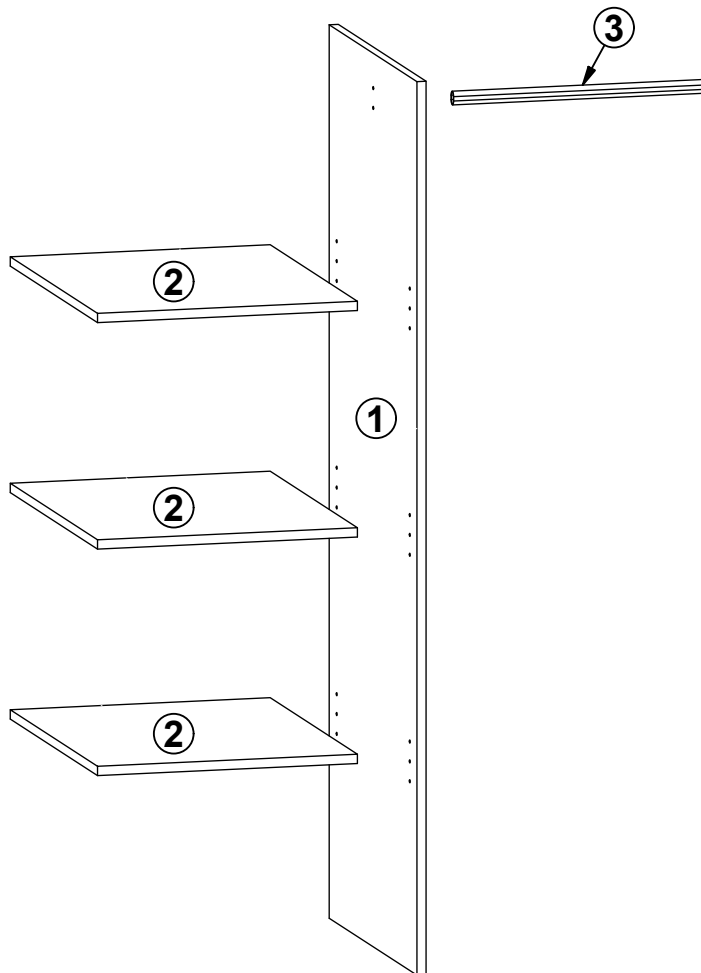

L

R

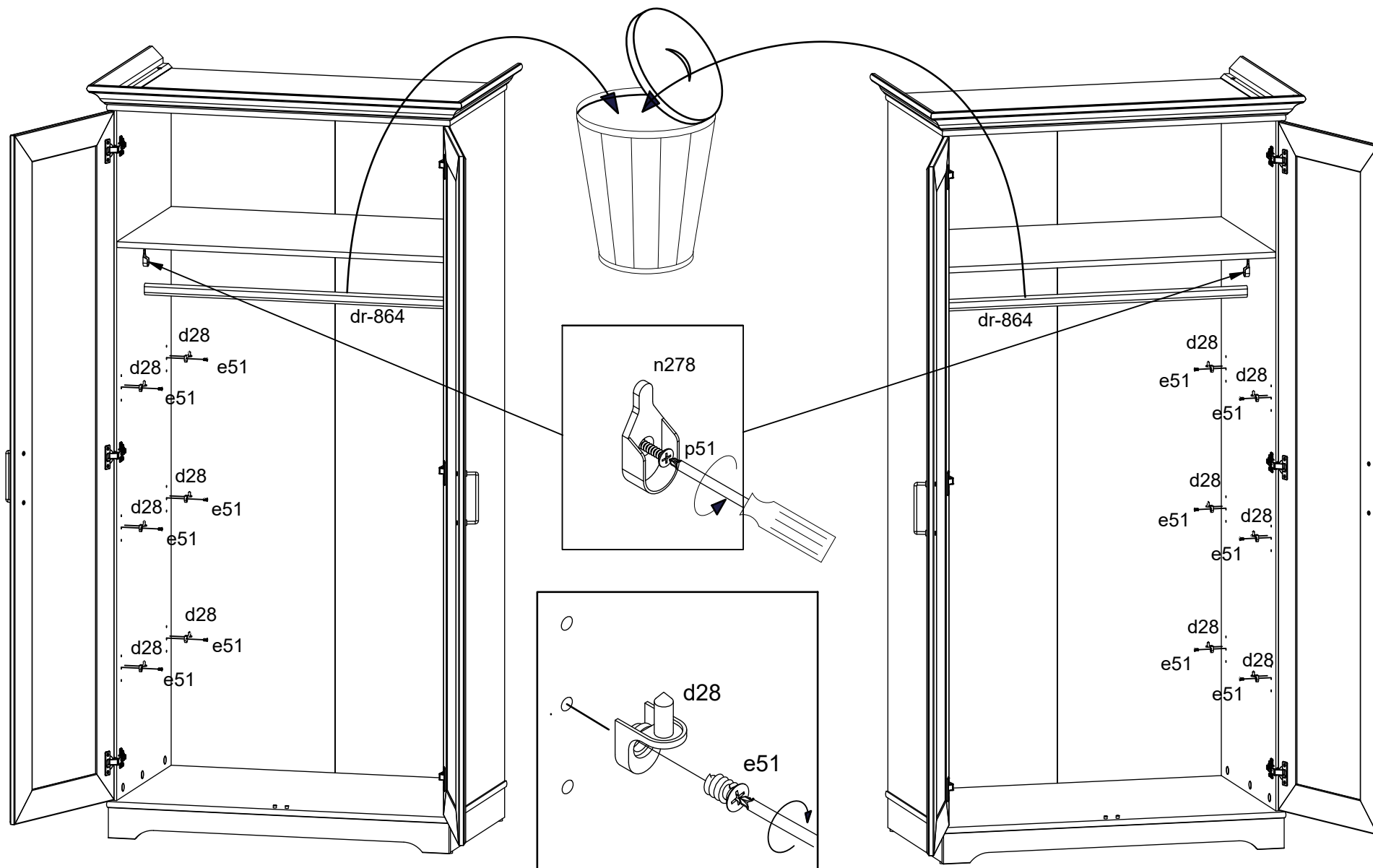
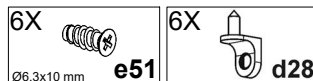

L

R

