

A**S641-SZF2D****ANGA**

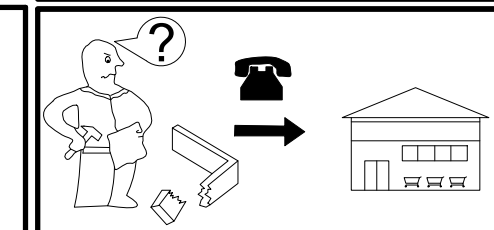

A	B1	B2	C1	C2	C3	D
1	S641-0013	-	1794	446	19	3/3
2	S641-1016	-	1800	540	15	2/3
3	S641-1017	-	1800	540	15	2/3
4	S641-2010	-	912	562	15	1/3
5	S641-2011	-	912	562	15	1/3
6	S641-3006	-	870	539	15	1/3
7	S641-4016	-	870	80	15	1/3
8	S641-4023	-	544	80	15	1/3
9	S641-5005	-.1	603	80	19	1/3
10	S641-5006	-.1	603	80	19	1/3
11	S641-5009	-	994	80	19	1/3
12	S641-5010	-	904	80	15	1/3
13	S641-9310	-	1824	895	2,5	2/3
14	dr-862		862	30	15	1/3

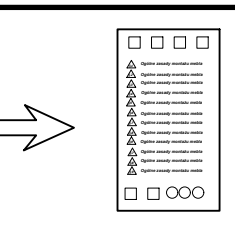

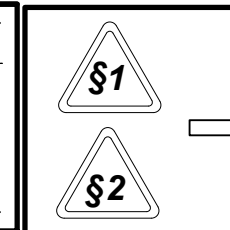
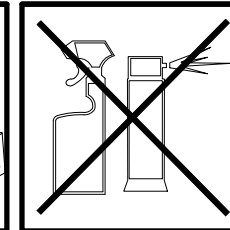
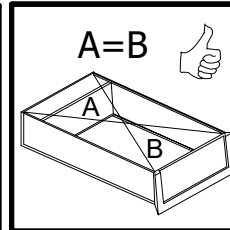
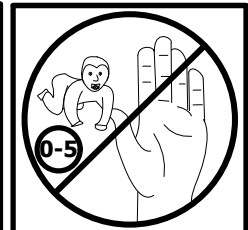
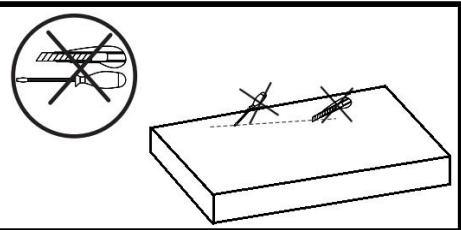
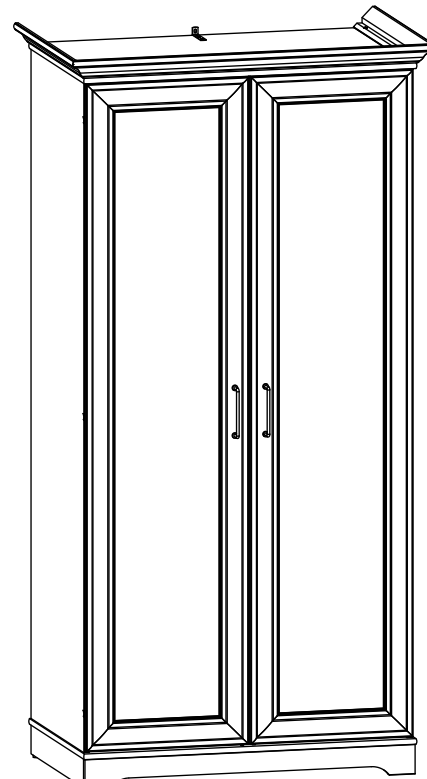
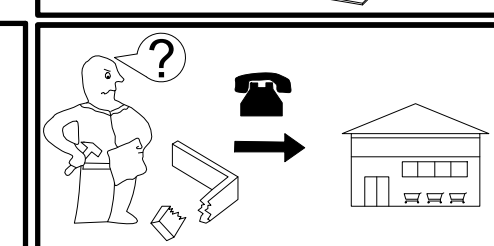
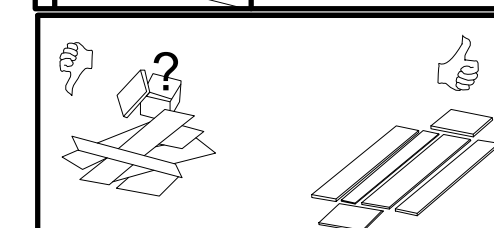
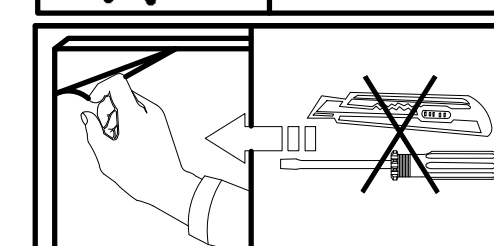
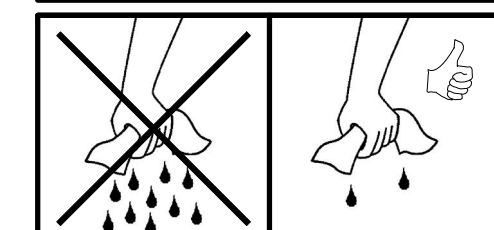
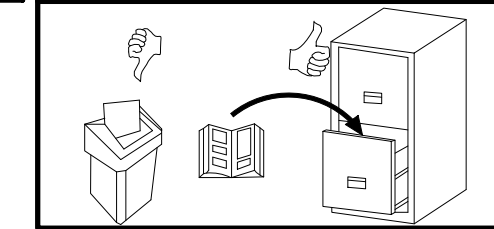
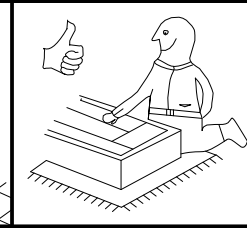
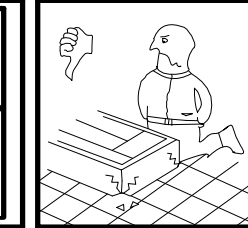
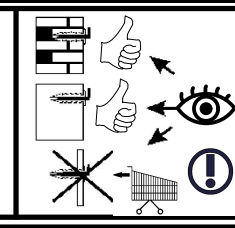
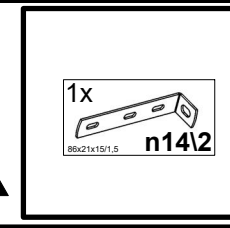
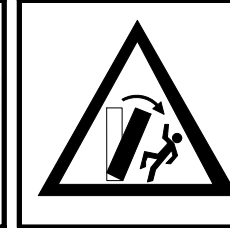
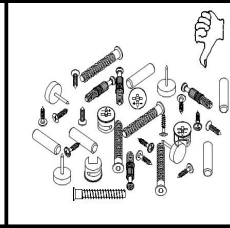
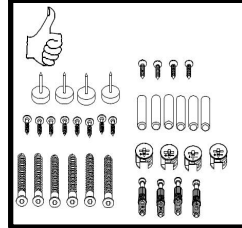
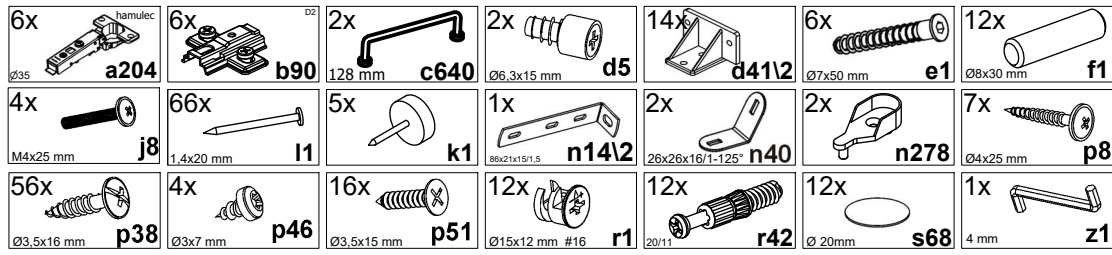
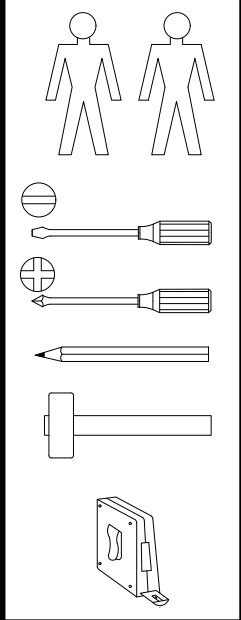
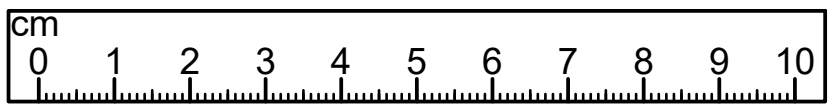
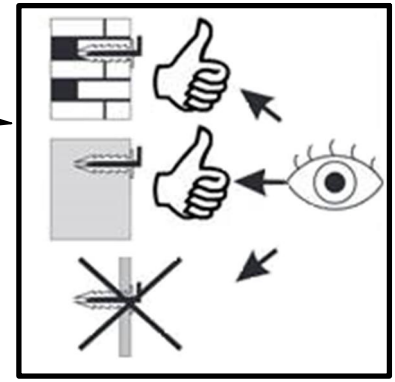
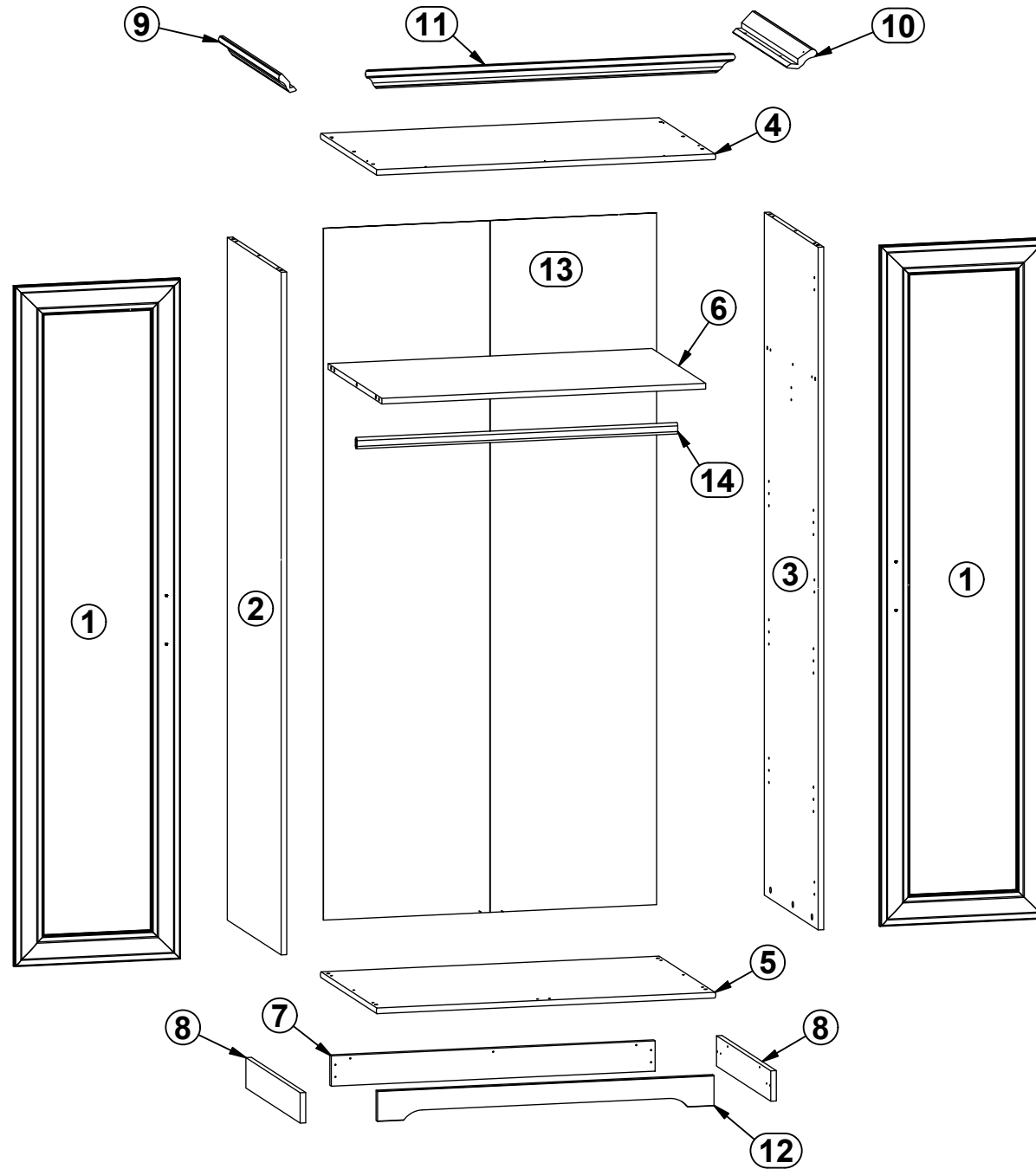

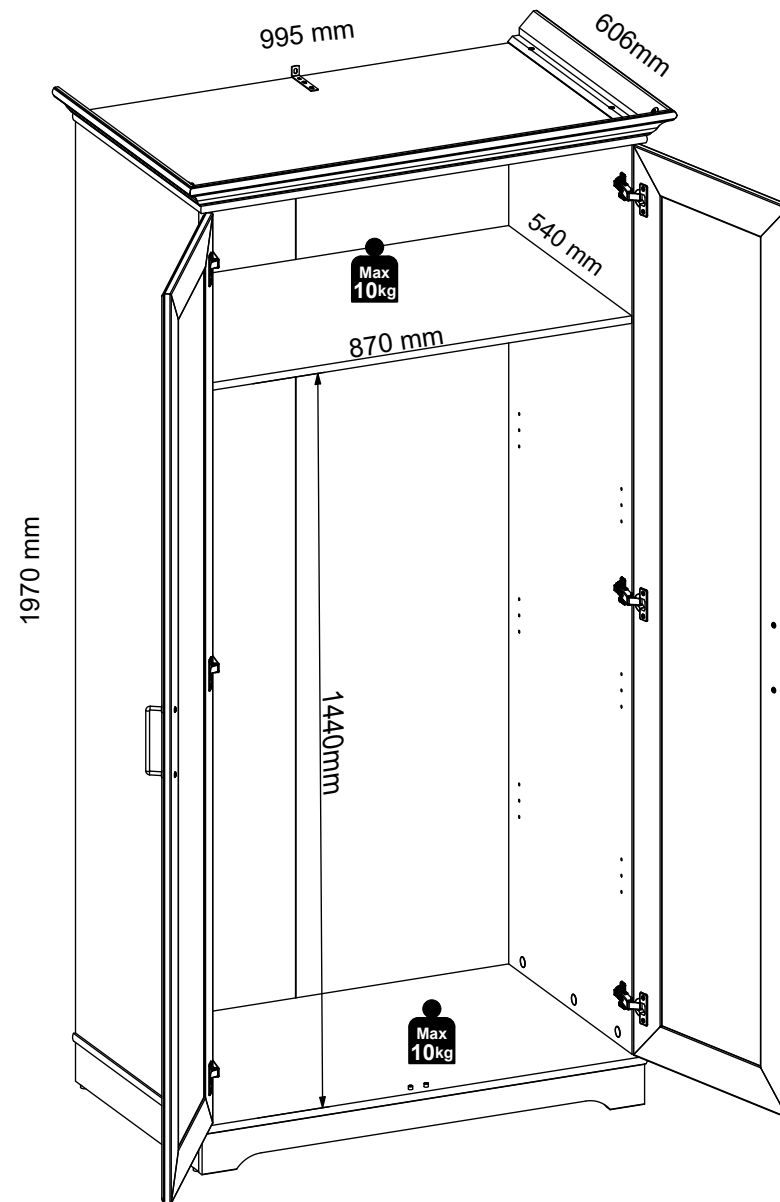

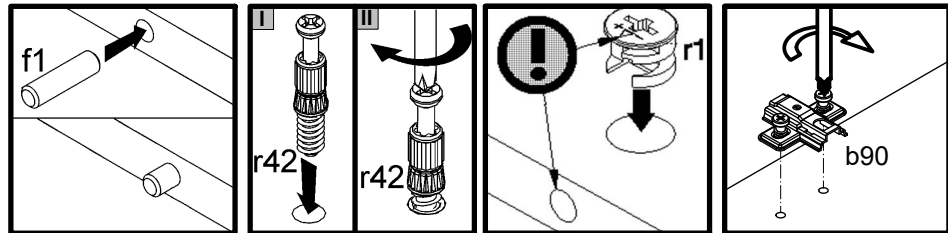
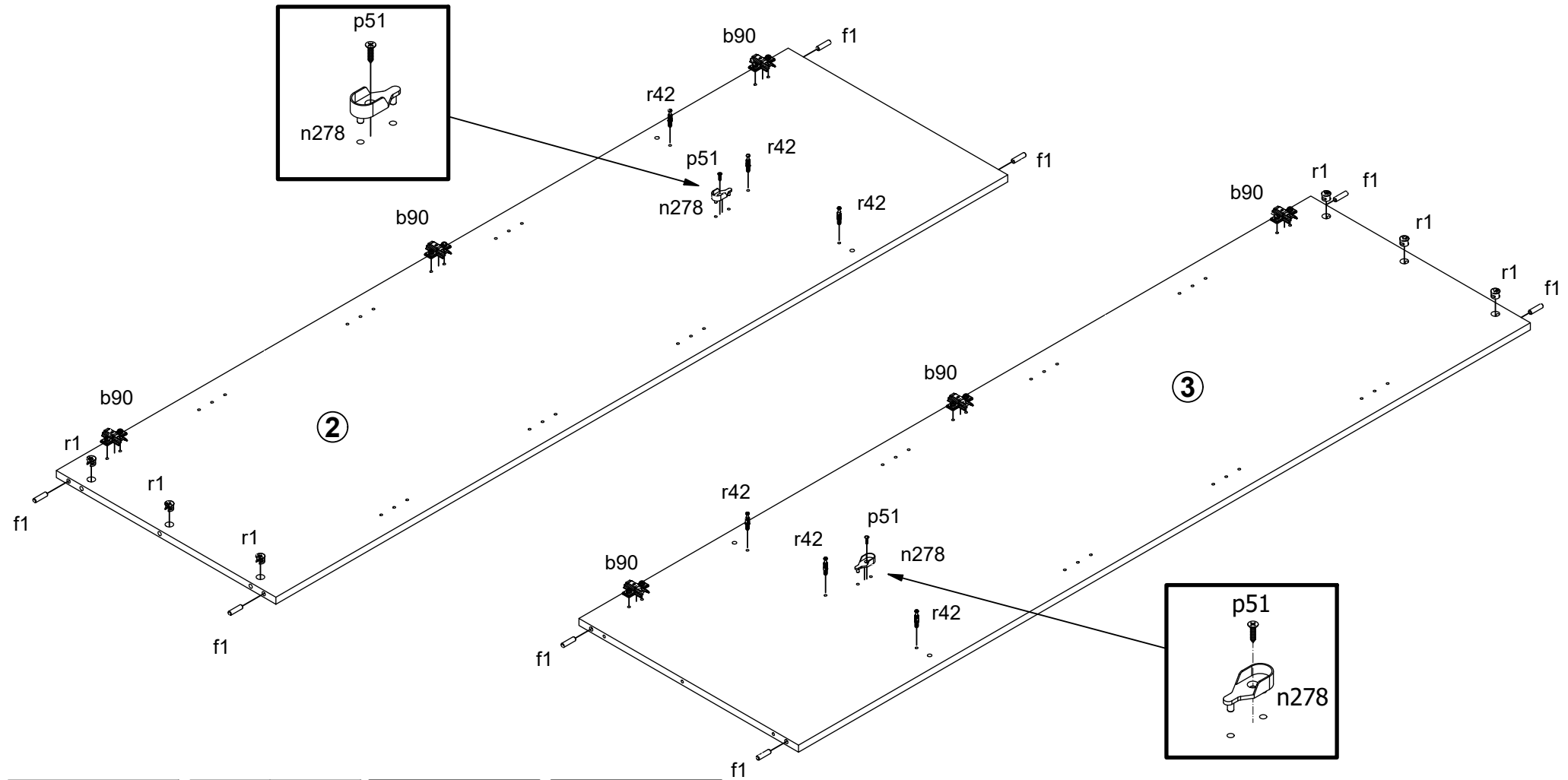
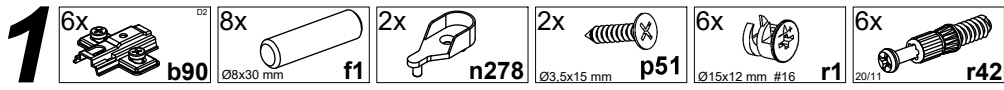

2

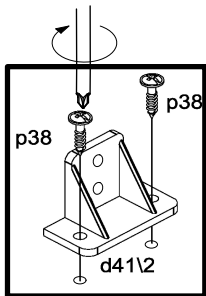
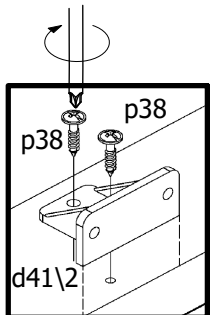
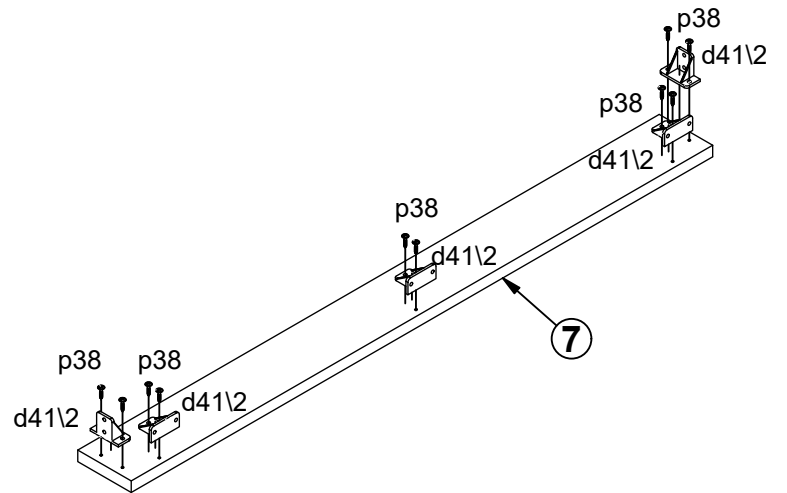
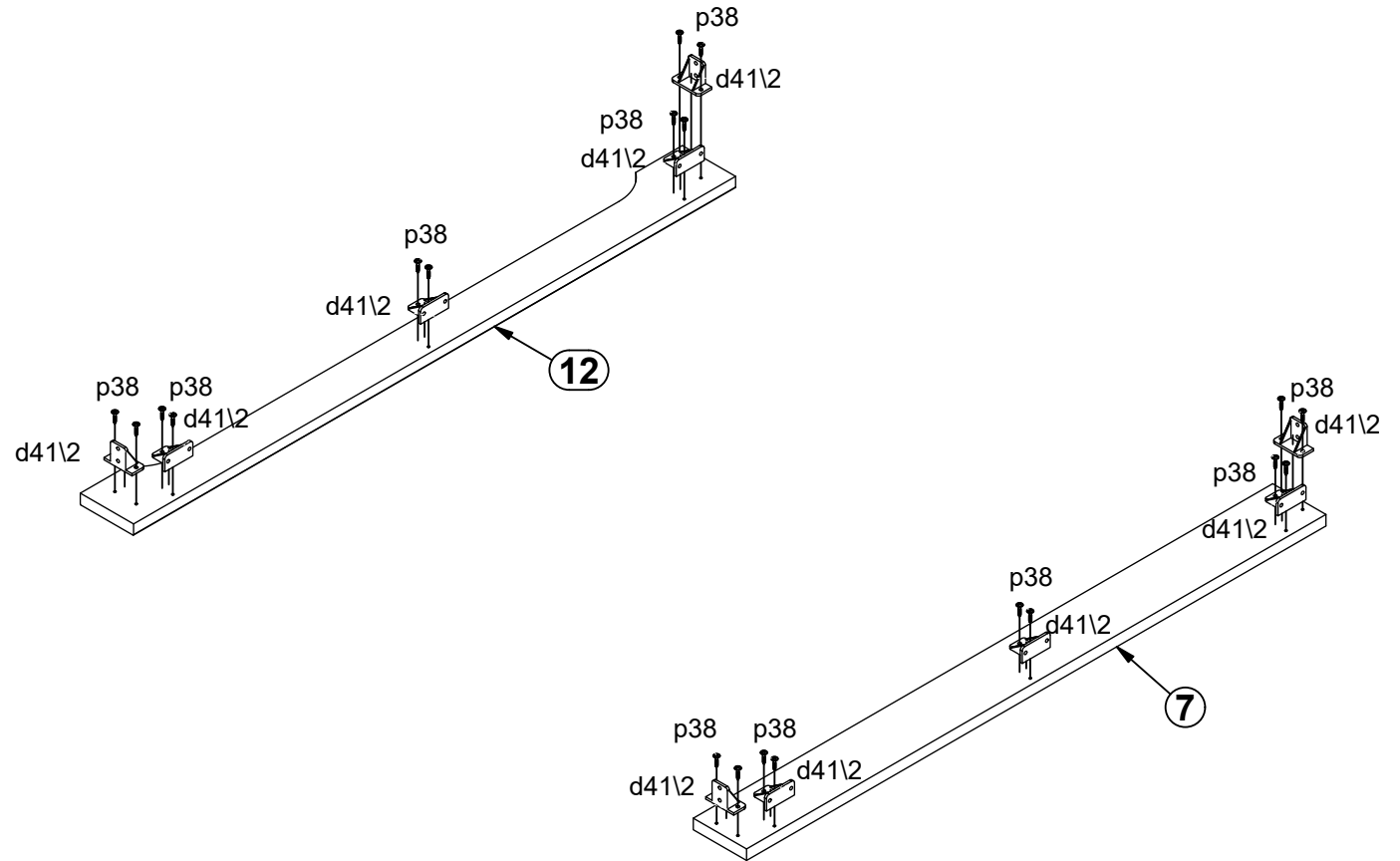
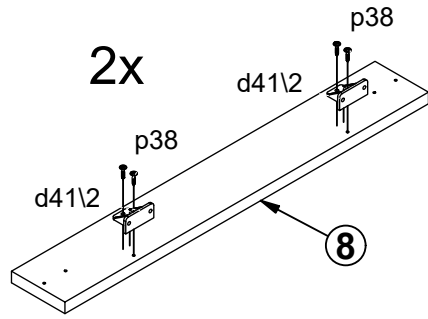
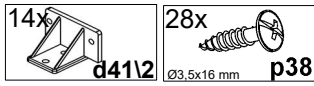

3

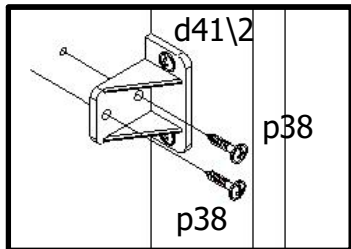
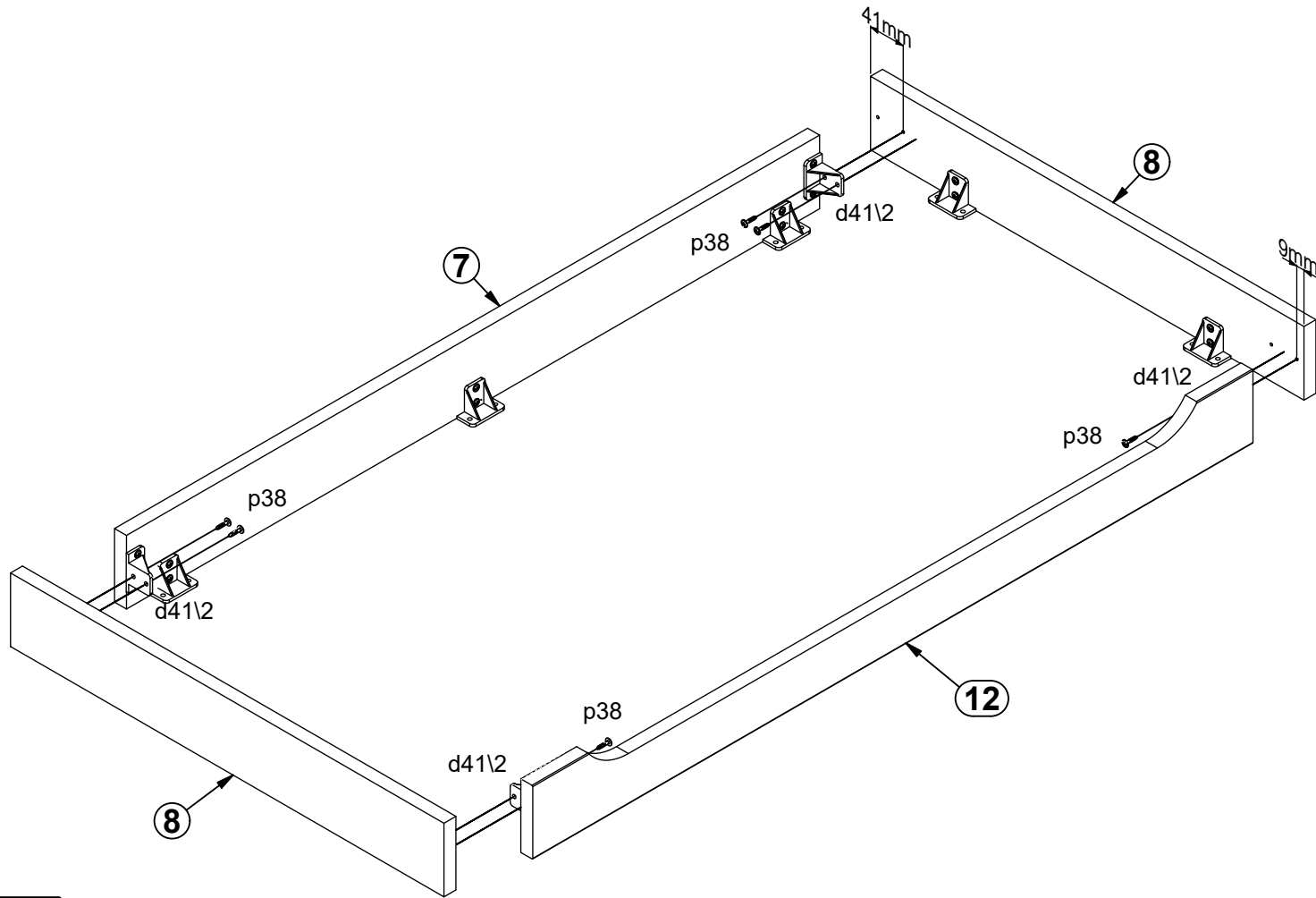
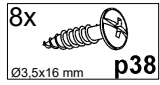

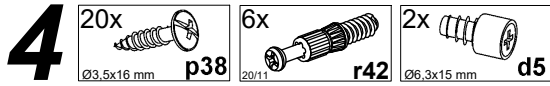

I

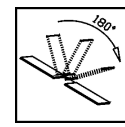
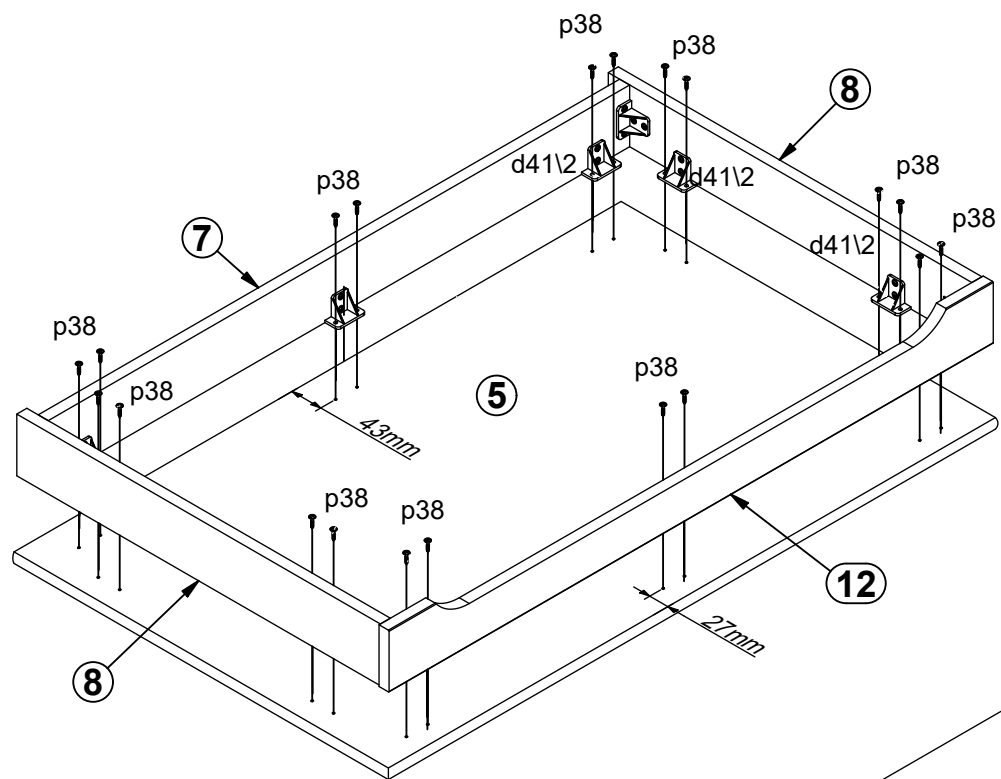

II

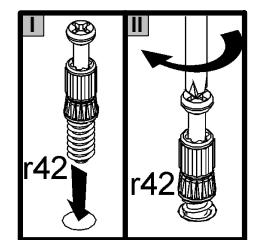
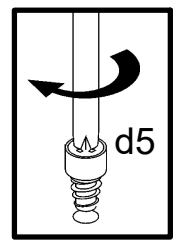
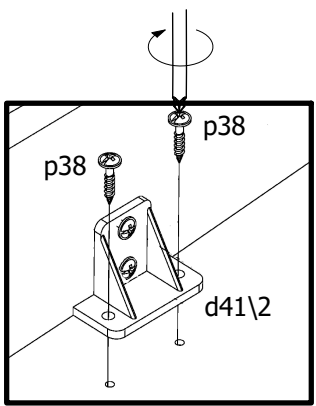
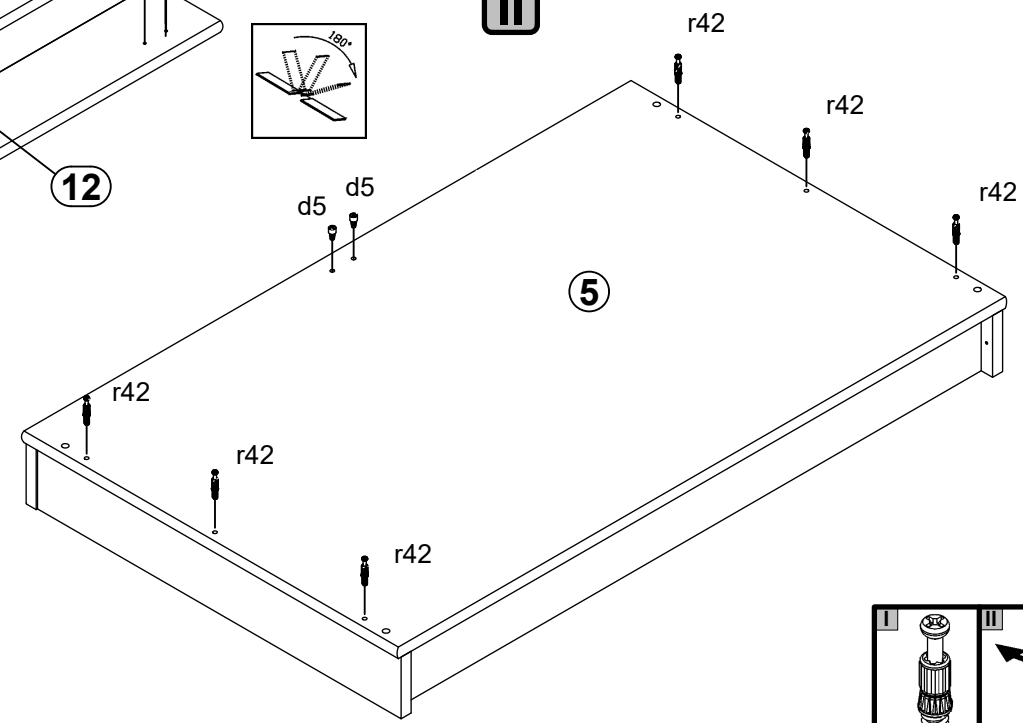

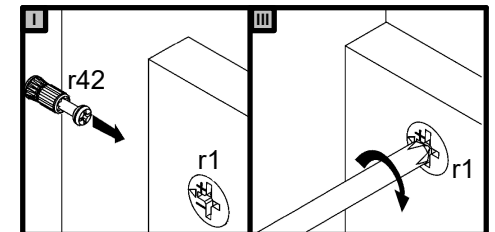
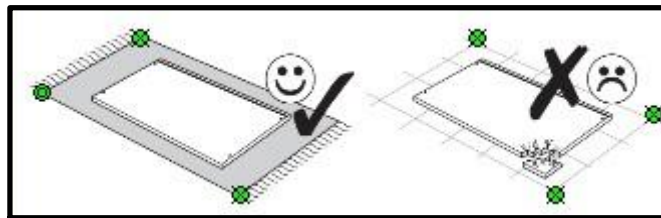
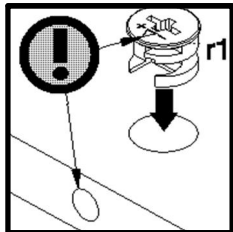
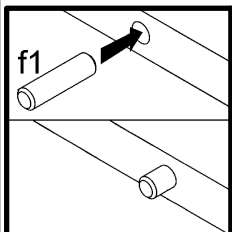
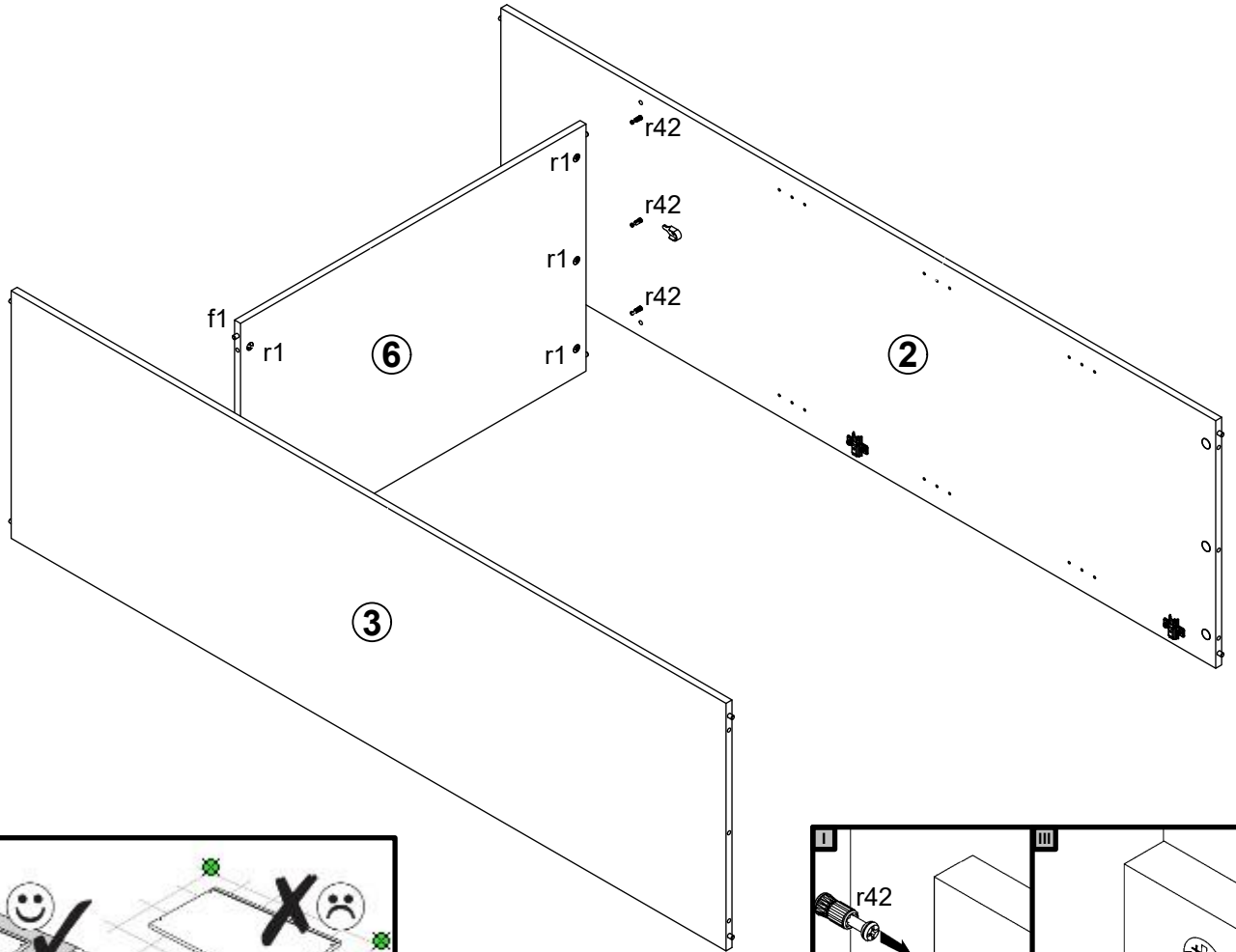
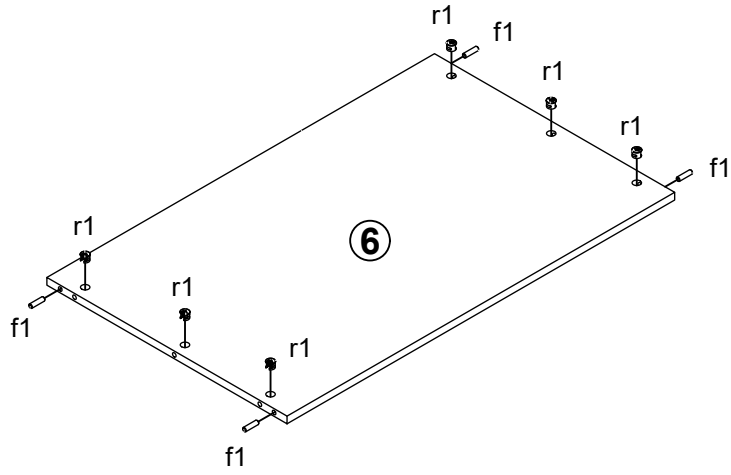
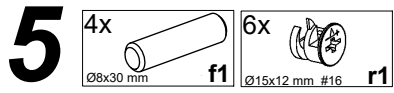

6

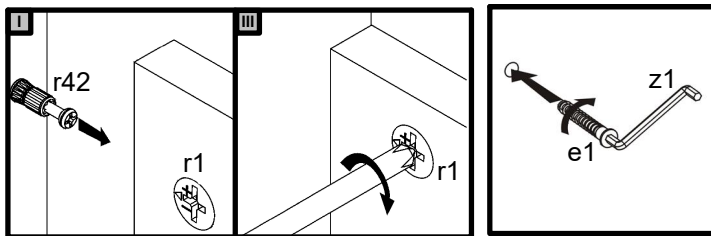
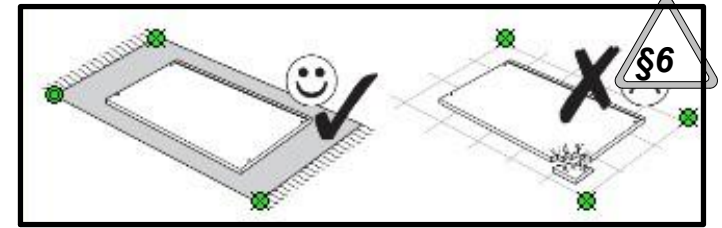
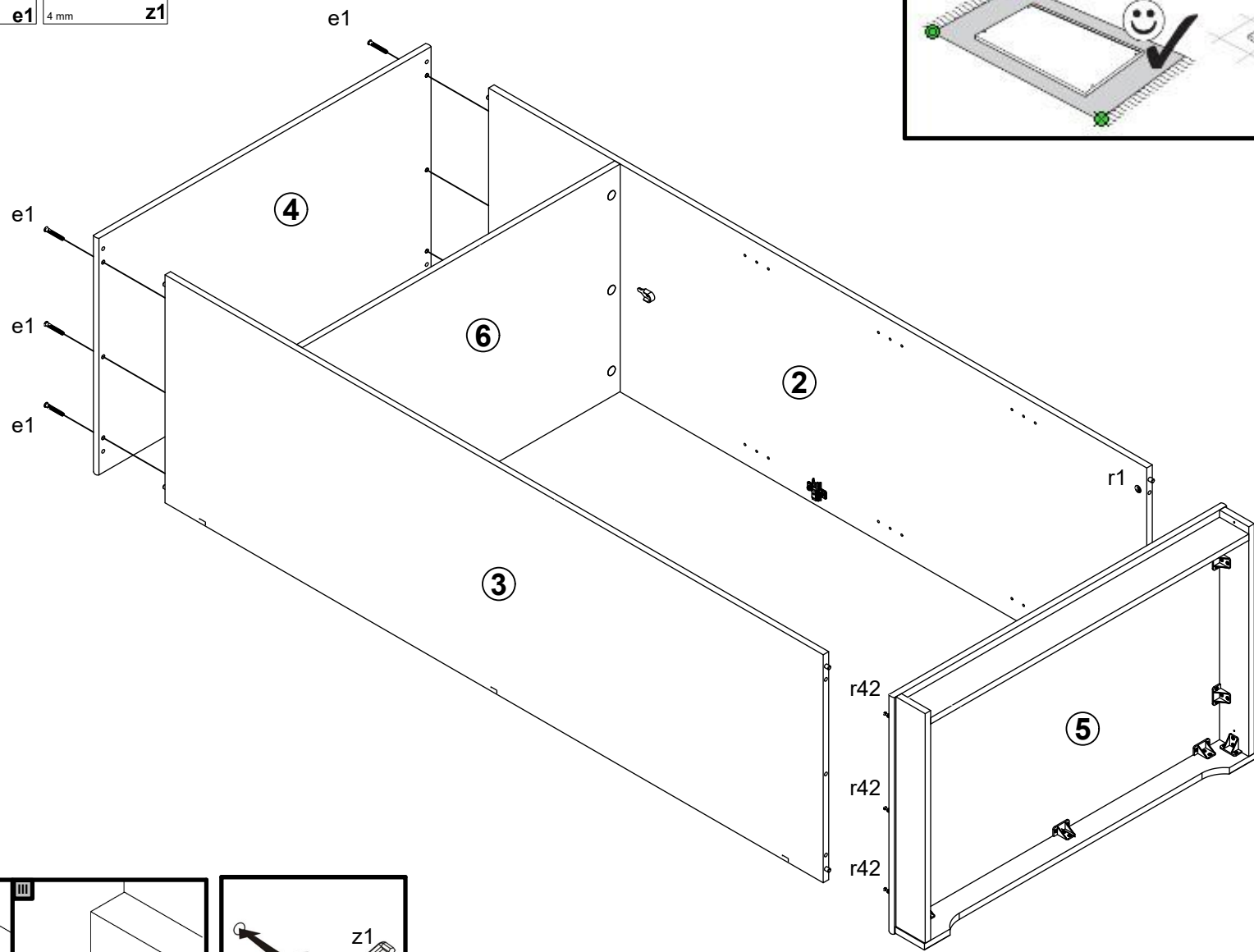
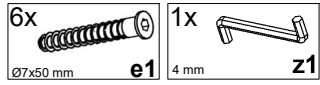

8

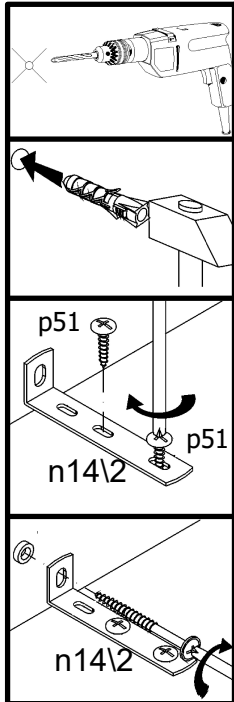
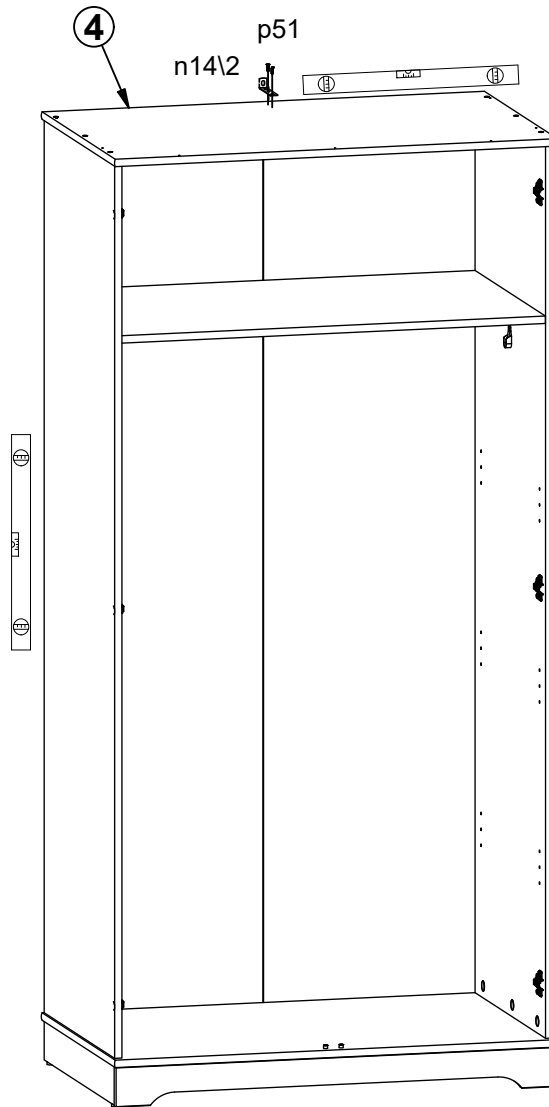
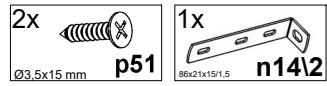

9

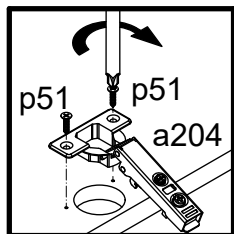
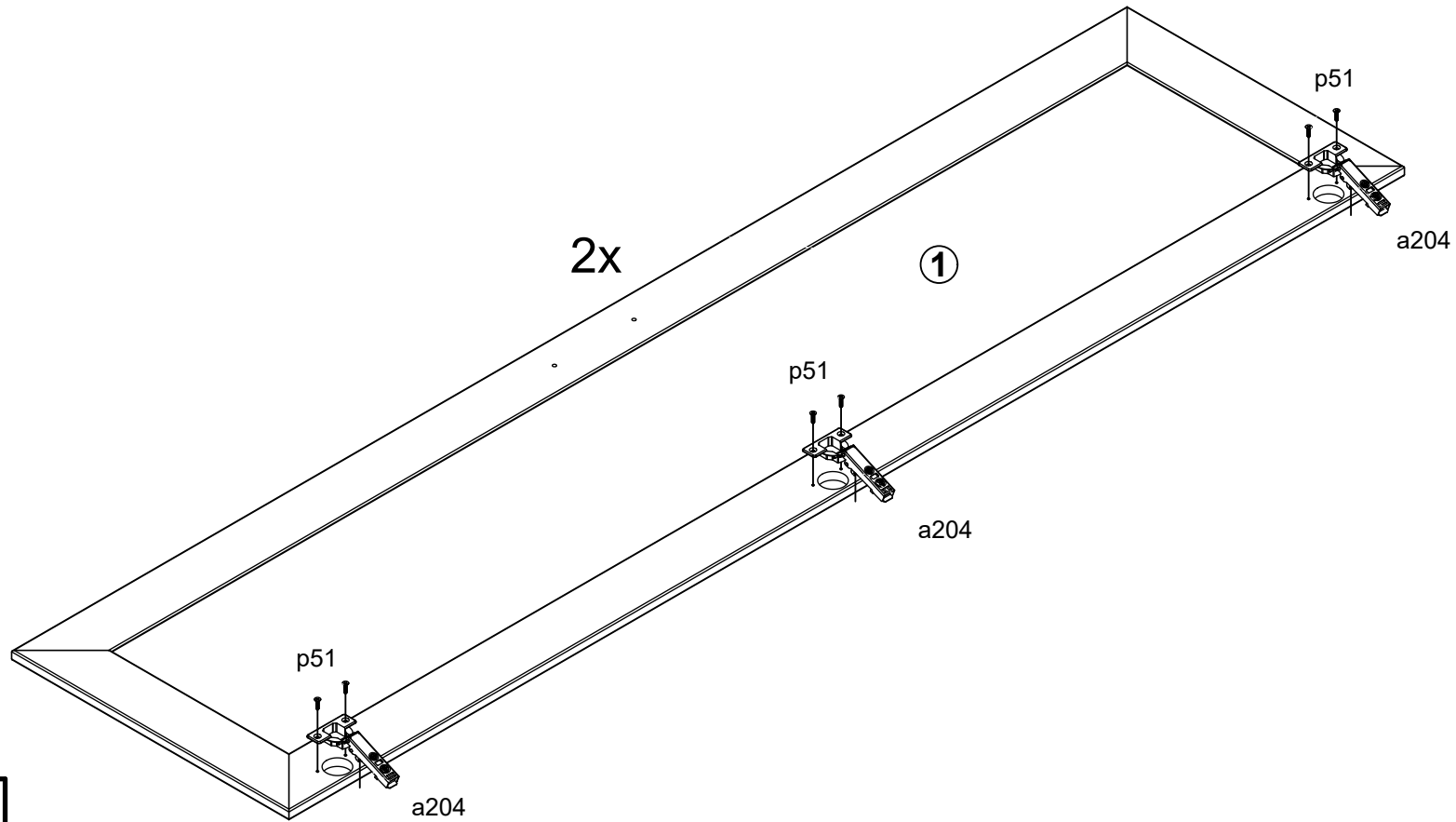
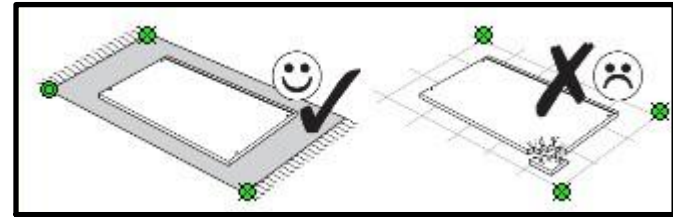
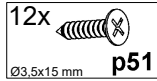

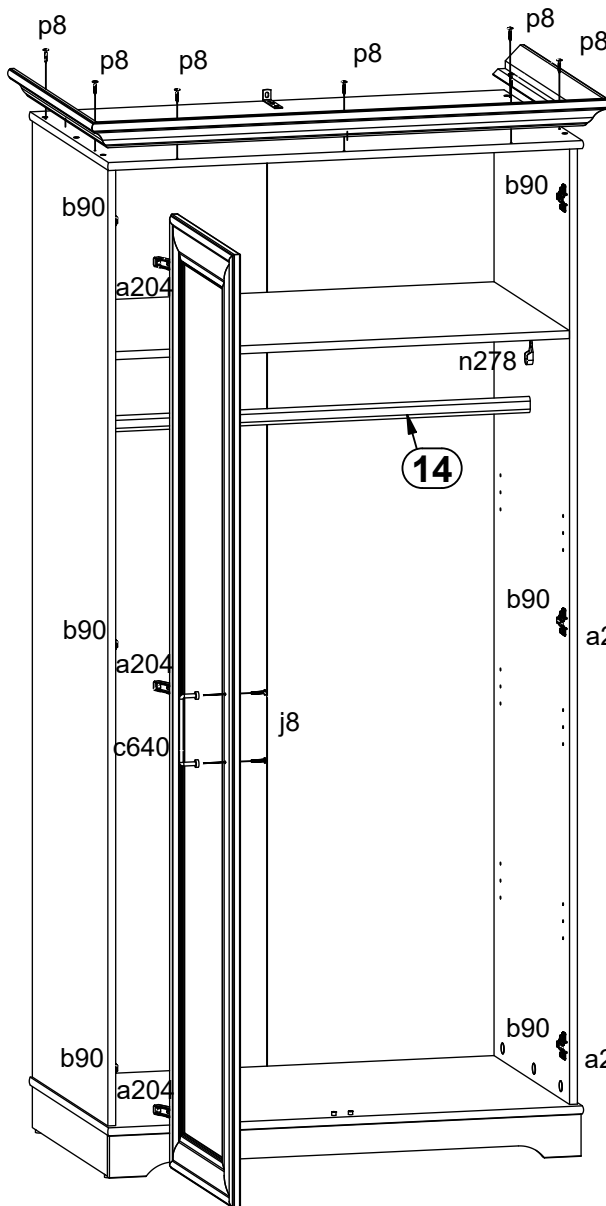
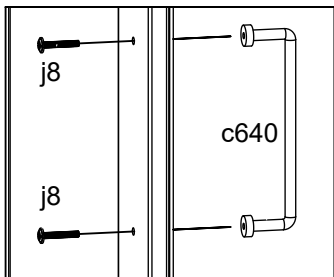
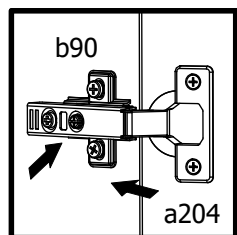
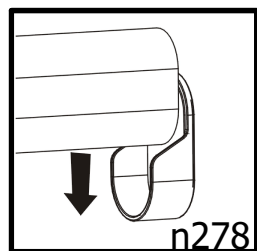
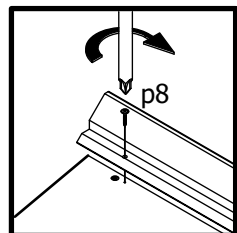
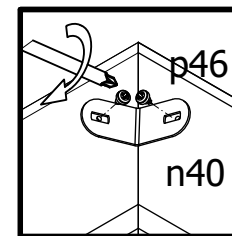
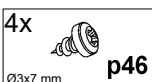
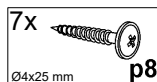
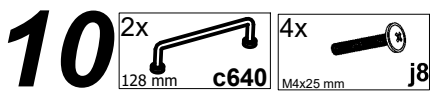

14

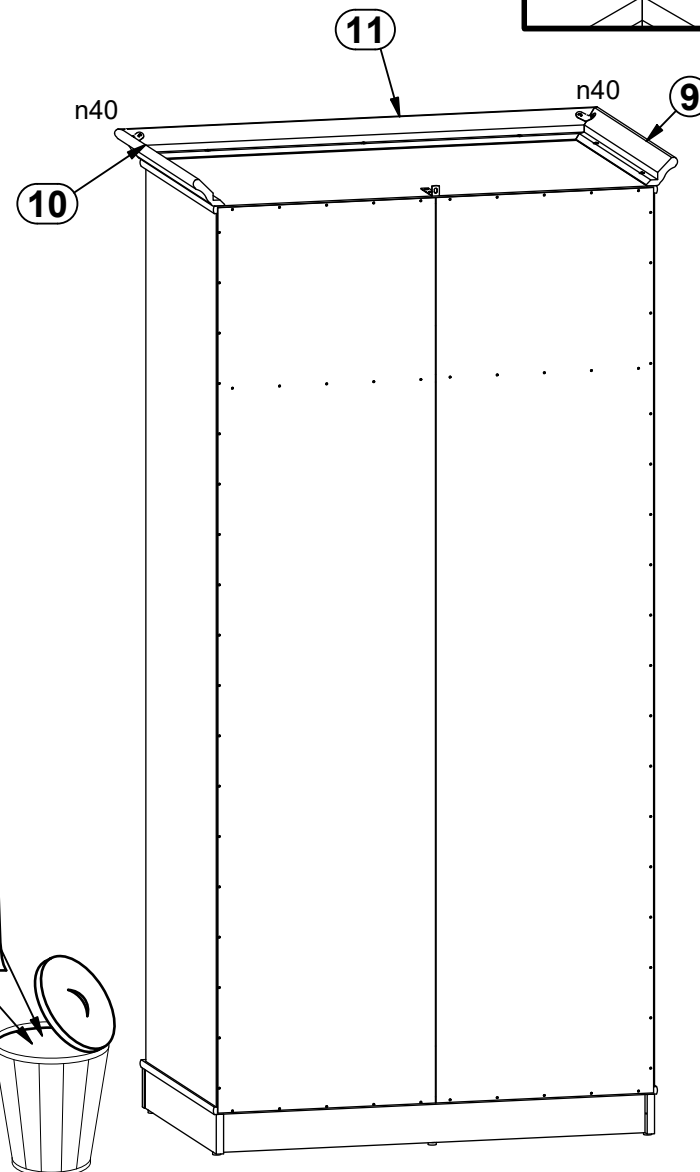

11

12x
Ø 20mm s68

