

Instructions for assembling furniture Instrukcja montażu mebli

Collection Kolekcja mebli

«MORTIZ»

Sideboard 2D3S
Komoda 2D3S

AH-073.06.00.00

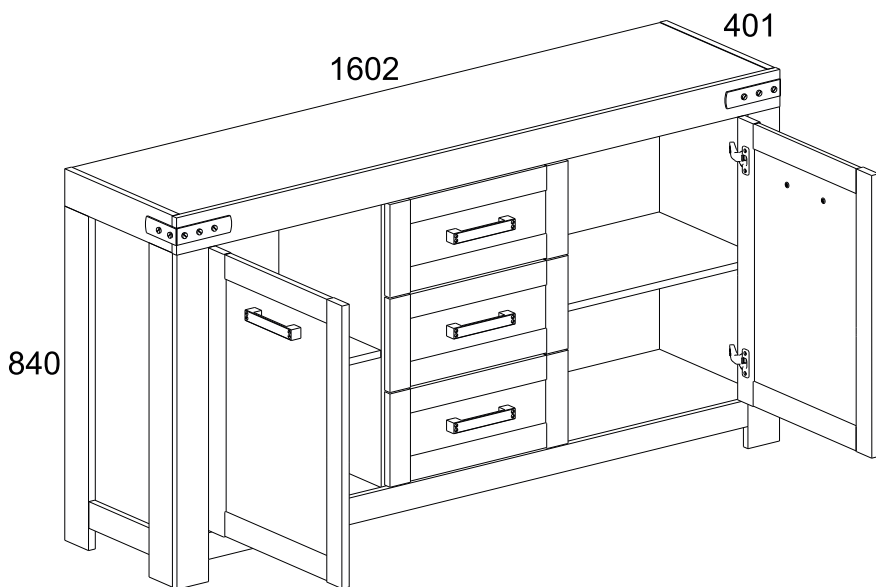







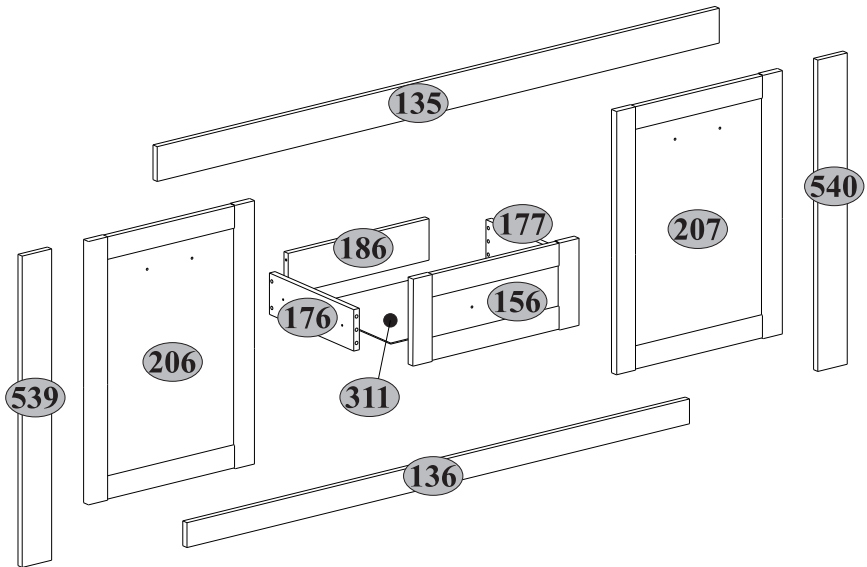
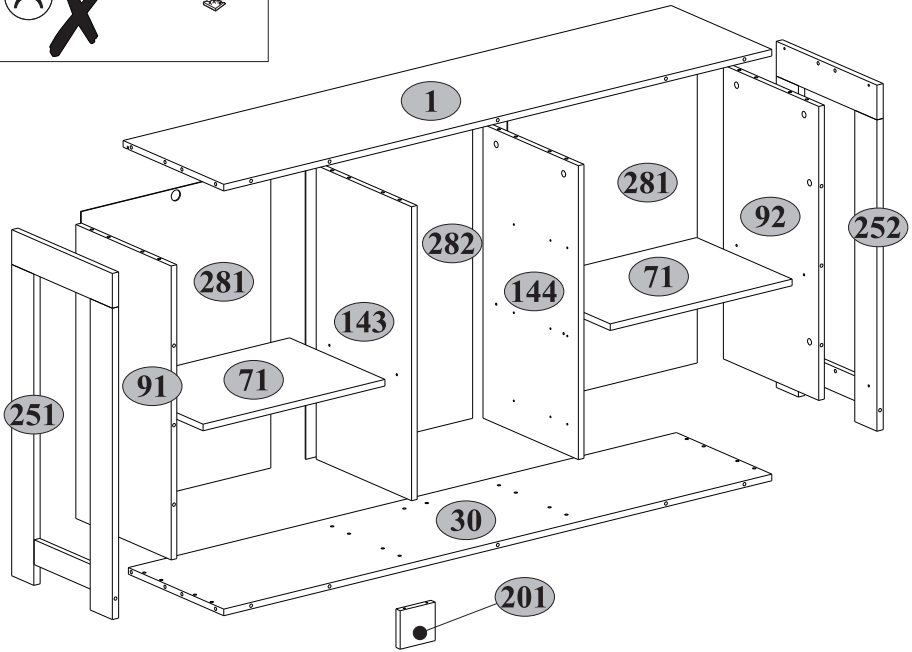
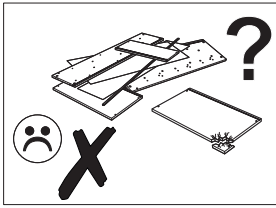





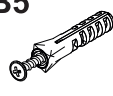
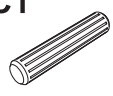
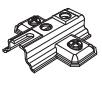
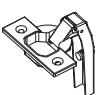
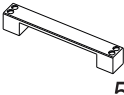





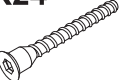

Production date
Data produkcji

Stamp of Quality Department
Pieczęć Działu Jakości

No	length	width	thickness	number	No pack
1	1564	382	16	1	2/3
30	1564	362	16	1	2/3
71	519	360	16	2	2/3
91	710	362	16	1	1/3
92	710	362	16	1	1/3
135	1602	84	18	1	2/3
136	1433	60	16	1	2/3
143	710	362	16	1	3/3
144	710	362	16	1	3/3
156	474	210	19	3	3/3
176	320	100	16	3	3/3
177	320	100	16	3	3/3
186	402	100	16	3	3/3
201	100	93	16	1	2/3
206	636	474	19	1	1/3
207	636	474	19	1	1/3
251	836	382	18	1	1/3
252	836	382	18	1	1/3
281	732	541	2,5	2	1/3
282	732	476	2,5	1	1/3
311	432	325	2,5	3	2/3
539	752	84	18	1	2/3
540	752	84	18	1	2/3



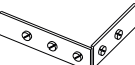
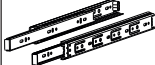

A1  7x34 40	A2  Ø15x12 40	B5  8x50 2	C1  8x35 42
D1  4	E2  4	H48  5	I  S4 1
N1  7	M5  M4x16 10	P5  8	Q  1,5x7 2
R101  3,5x16 52	R23  6,3x13 8	R24  7x50 22	R27  5,0x13 30
R102  3,5x16 16	S1  6	S3  6	S5  Ø18 16
U.1  45x35x15 2	U5  36x36 4	V8  2	Z10  300 3
R100  3,5x13 12			

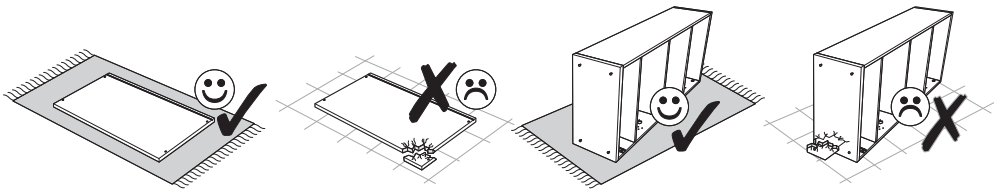
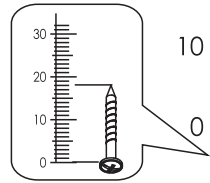
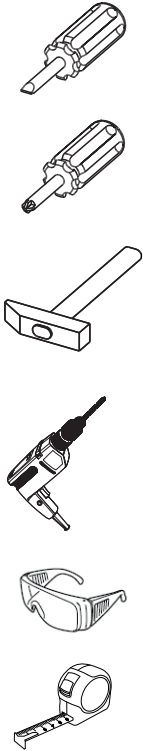

1

A1



7x34

A2



8 Ø15x12

C1



12 8x35

8

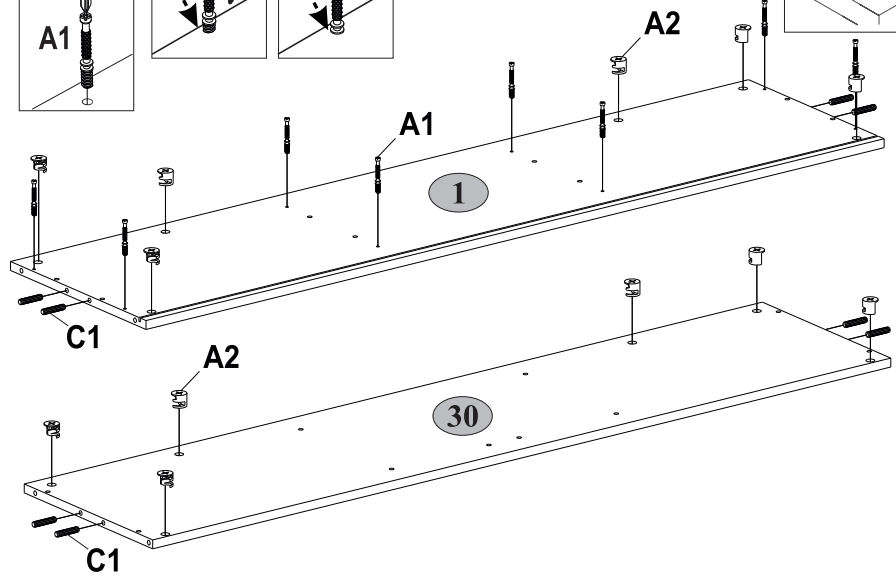
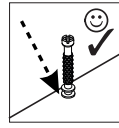
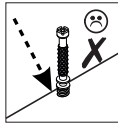
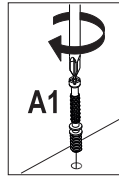
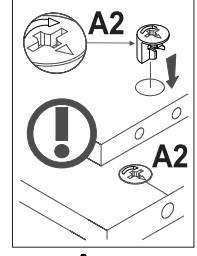

2

A2



Ø15x12

C1



8 8x35

P5



8

4

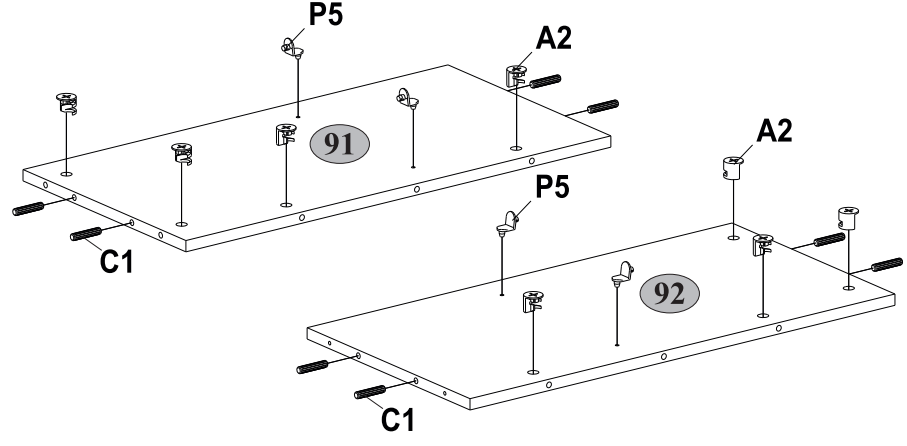
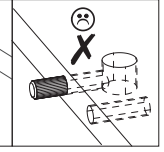
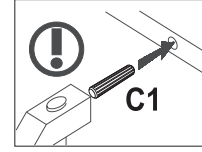

3

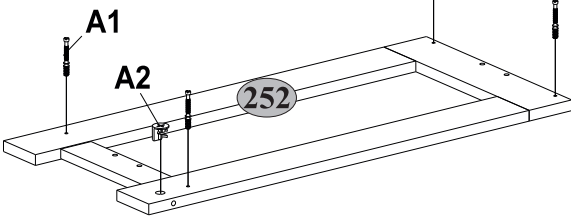
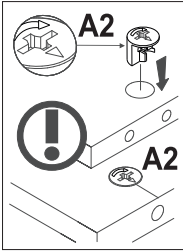
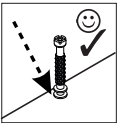
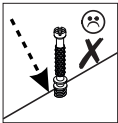
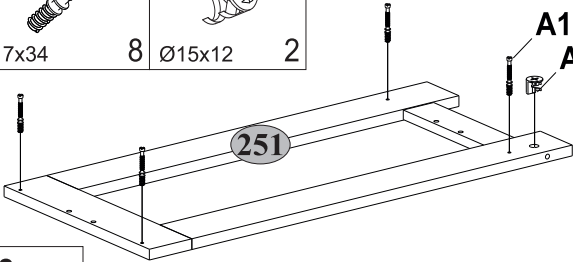
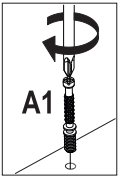
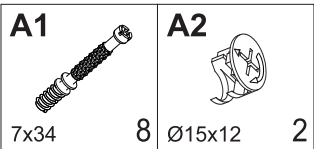

4

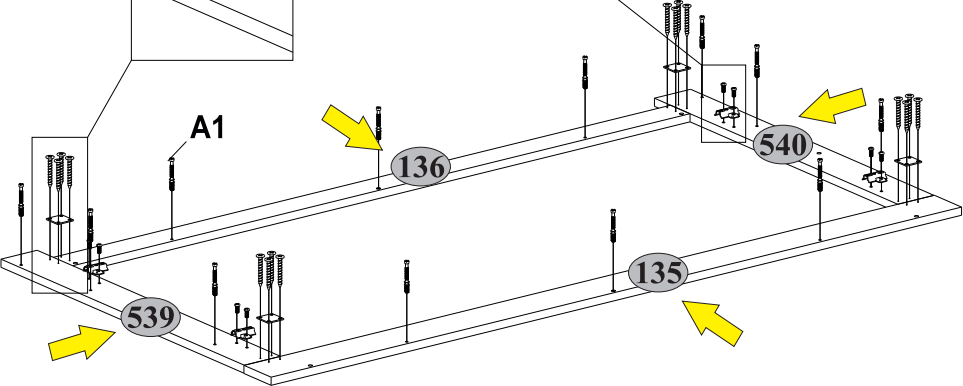
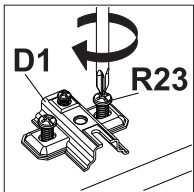
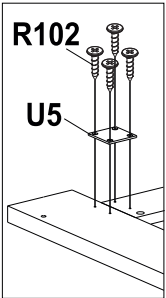
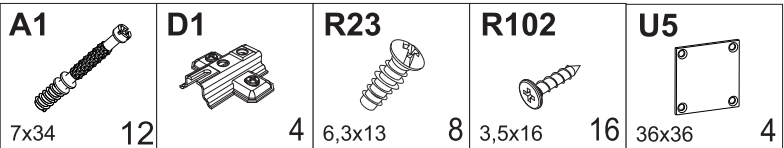

5

A2



Ø15x12

4

C1

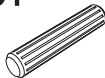

8x35

8

P5



4

R27



5,0x13

18

Z10

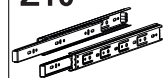

300

3

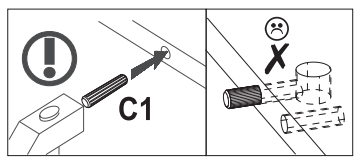
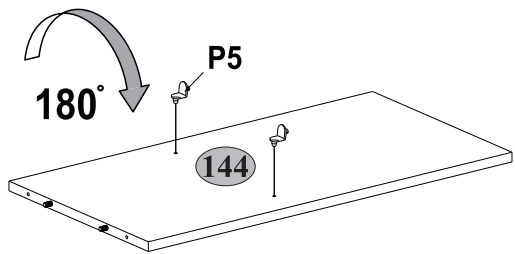
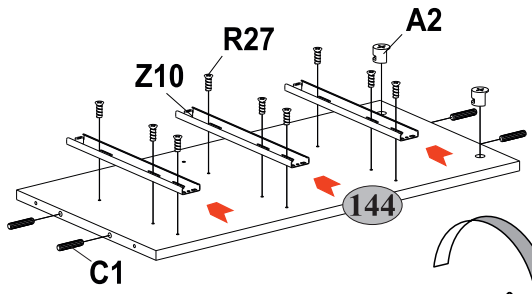
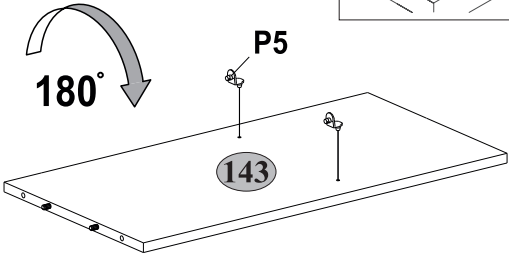
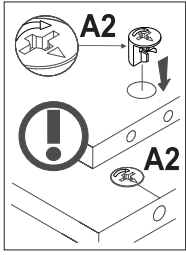
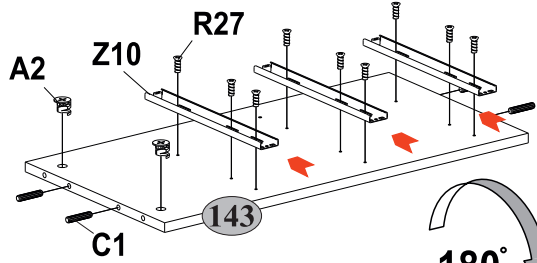
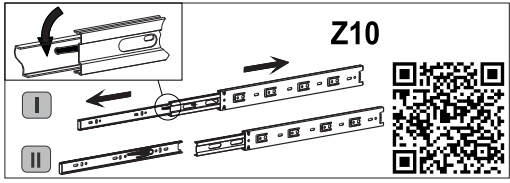
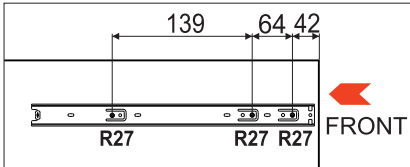

6

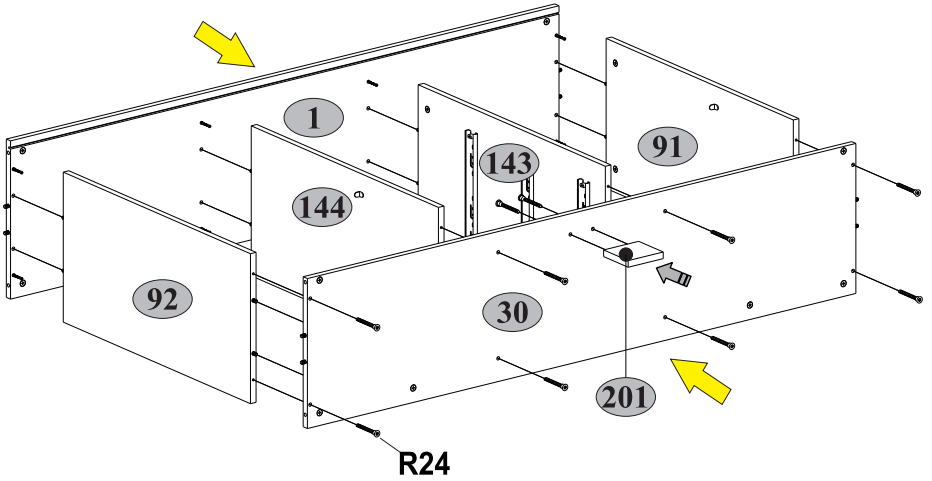
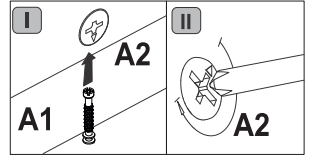
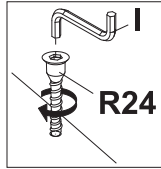
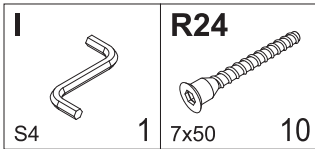



7

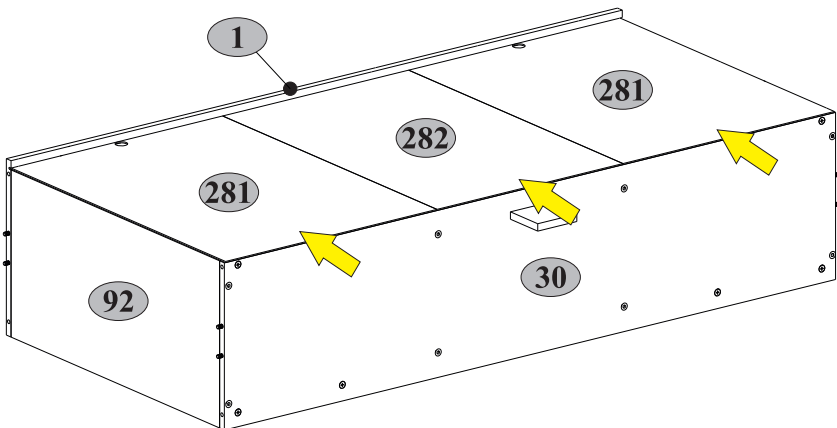

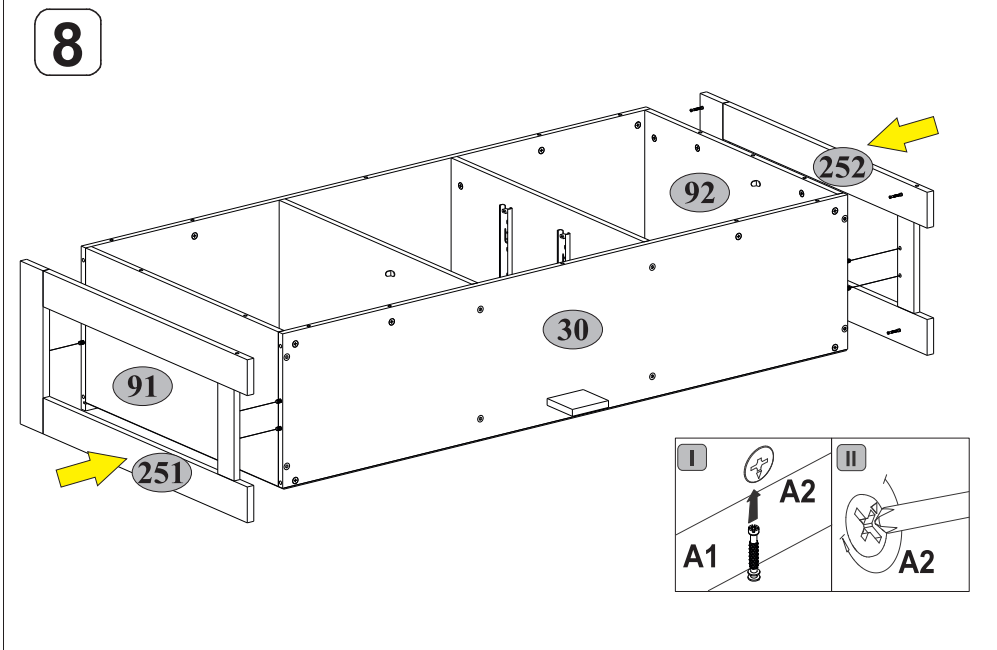
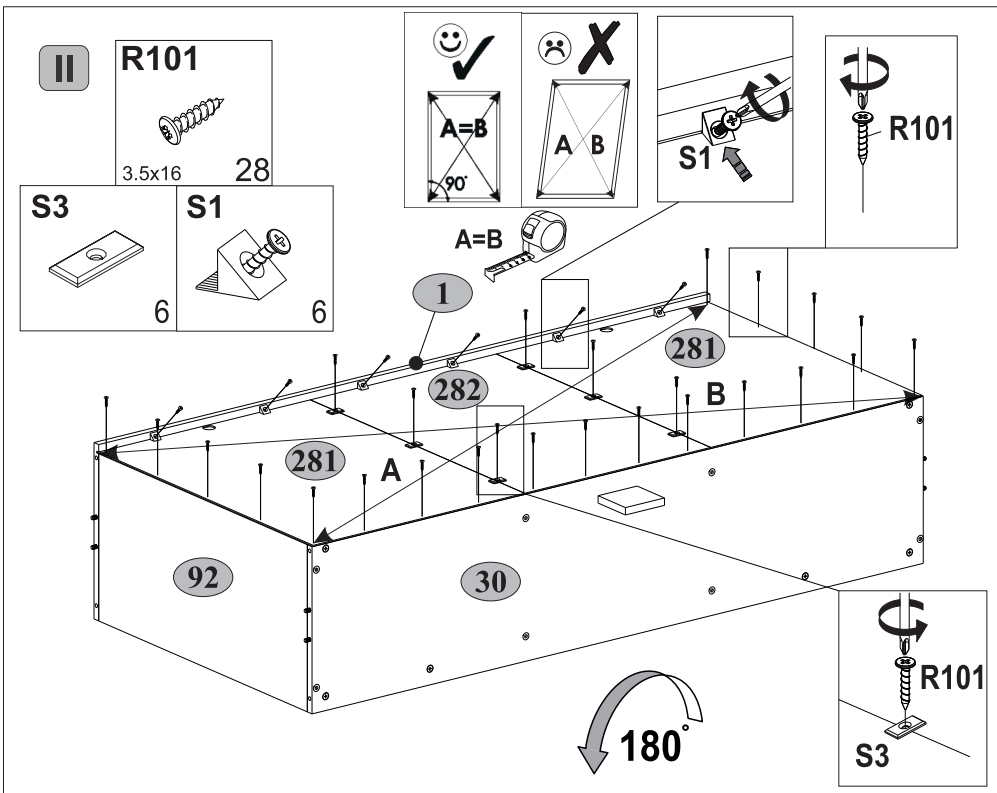
I



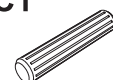

9

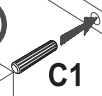

C1  8x35	N1  6	N1  7
--	---	---

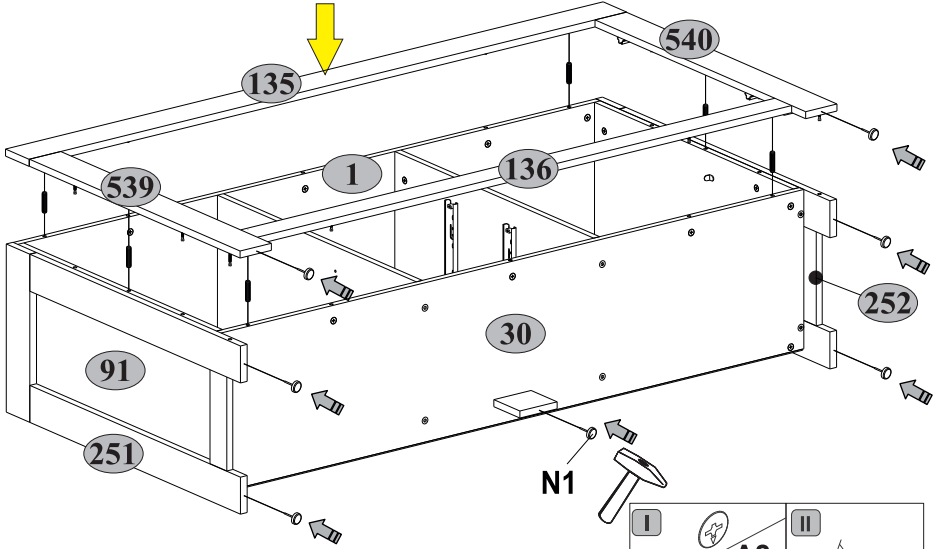
  C1	 
---	--

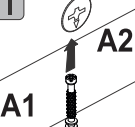
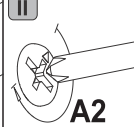

I  A1 A2	II  A2
--	--

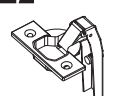
10

E2  4	R100  3.5x13	8
--	--	----------

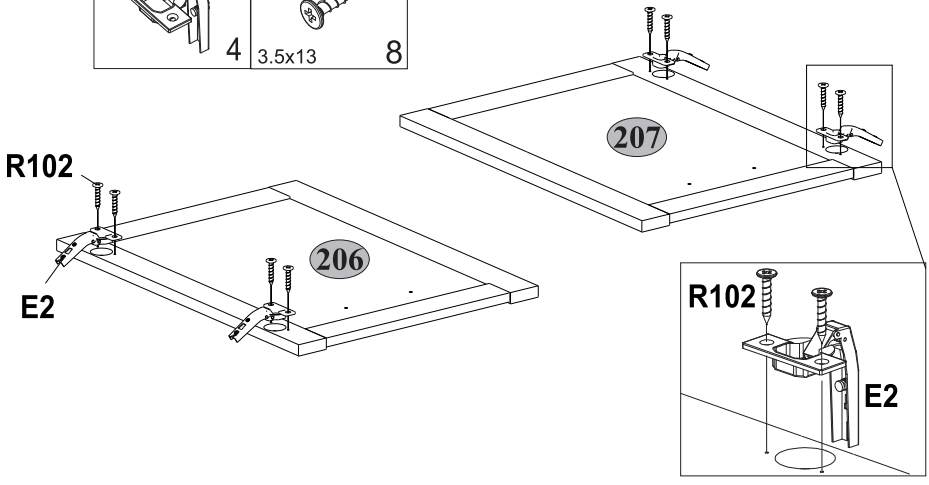

11
x3

A1 7x34 12	A2 Ø15x12 12	C1 8x35 12	H48 3	I S4 1
M5 M4x16 6	R24 7x50 12	R27 5,0x13 12	Z10 300 3	

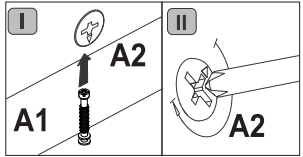
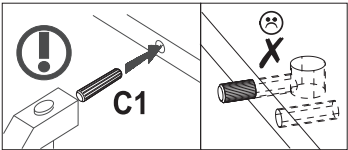
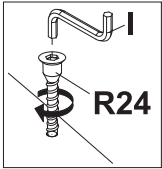
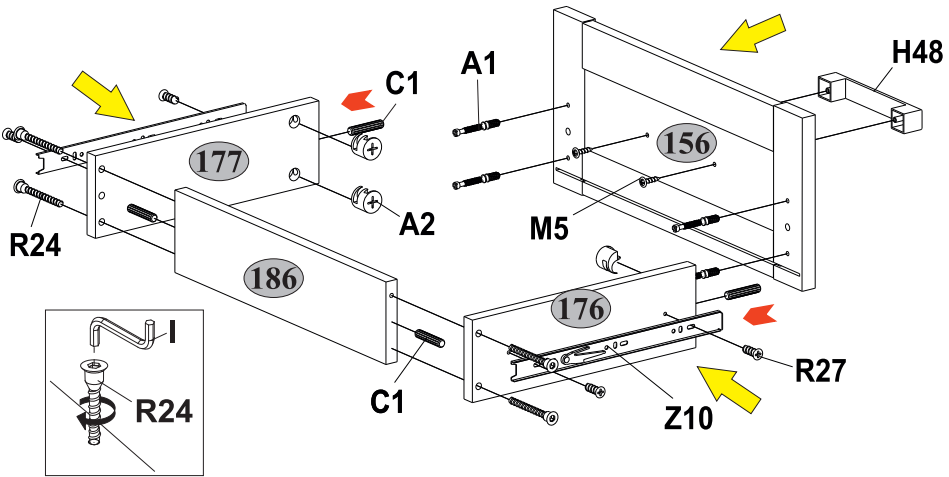
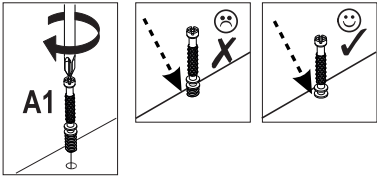
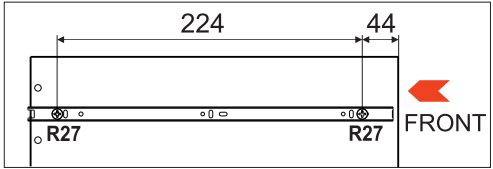
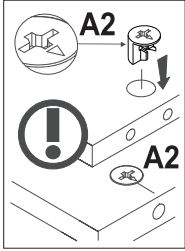

12

R101

x3

3.5x16

24

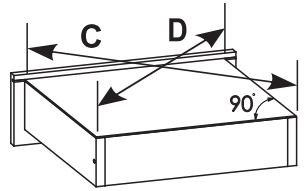
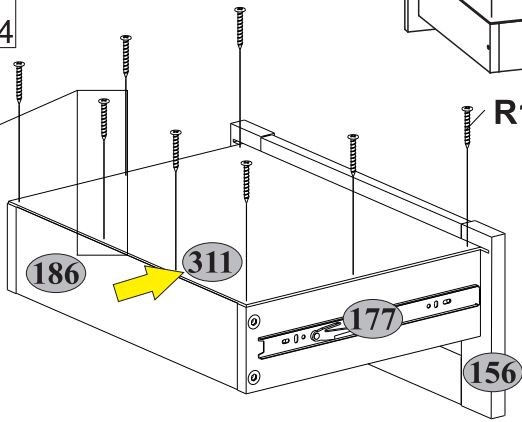
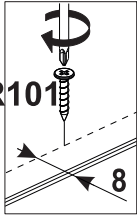

C=D

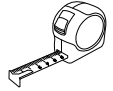

13

B5

S5

2

3.5x13

2

Ø18

16

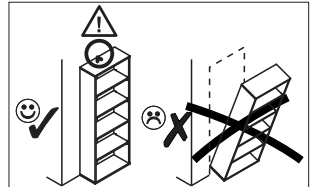

U.1

45x35x15

2

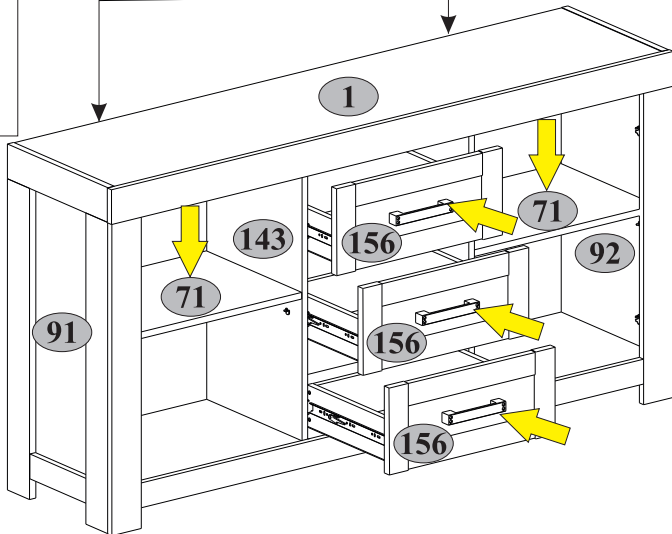
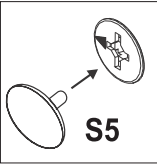
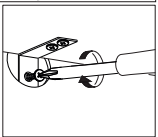
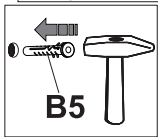
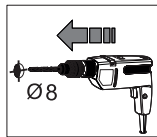
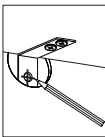
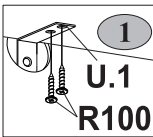

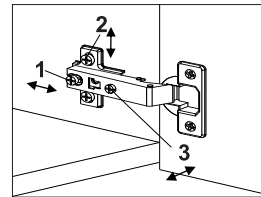
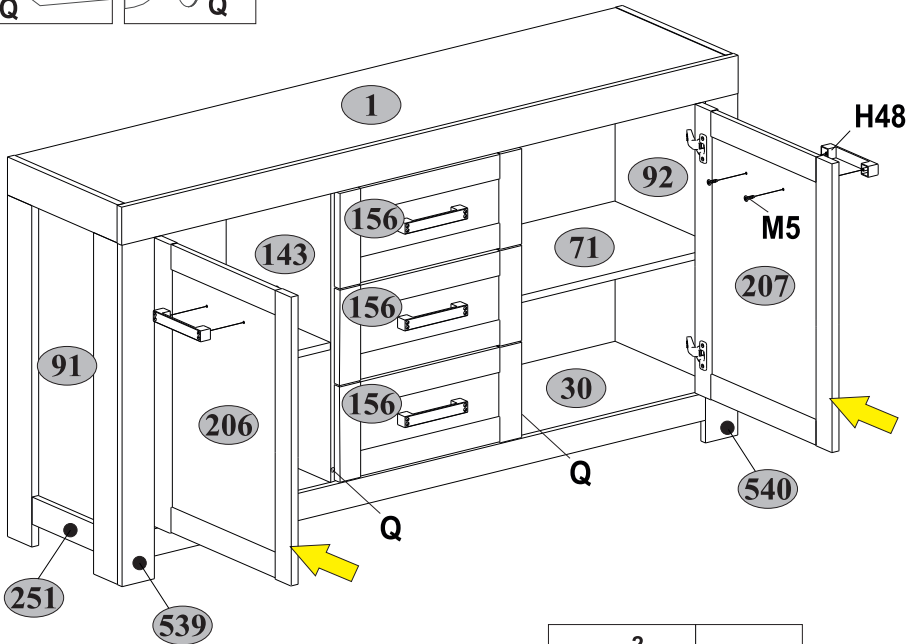
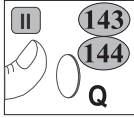
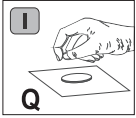
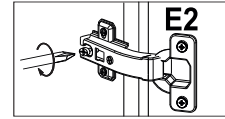
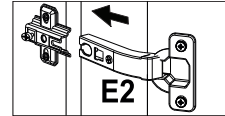
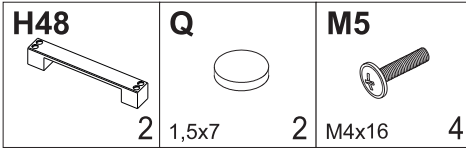
14

30 **71** **156**  max. 5 kg

1  max. 15 kg

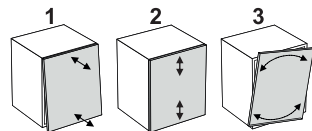

15

V8

