

A	B	C	D	
1	S428-0018	1446	496	2/2
2	S428-1026	1546	400	2/2
3	S428-1027	1546	400	2/2
4	S428-1028	1546	380	2/2
5	S428-2018	969	400	1/2
6	S428-2019	969	400	1/2
7	S428-3010	531	380	1/2
8	S428-3011	530	379	1/2
9	S428-3012	391	379	1/2
10	S428-5014	970	62	1/2
11	S428-5015	1453	62	2/2
12	S428-5031	1453	62	2/2
13	S428-9010	1556	404	2/2
14	S428-9306	1556	543	2/2

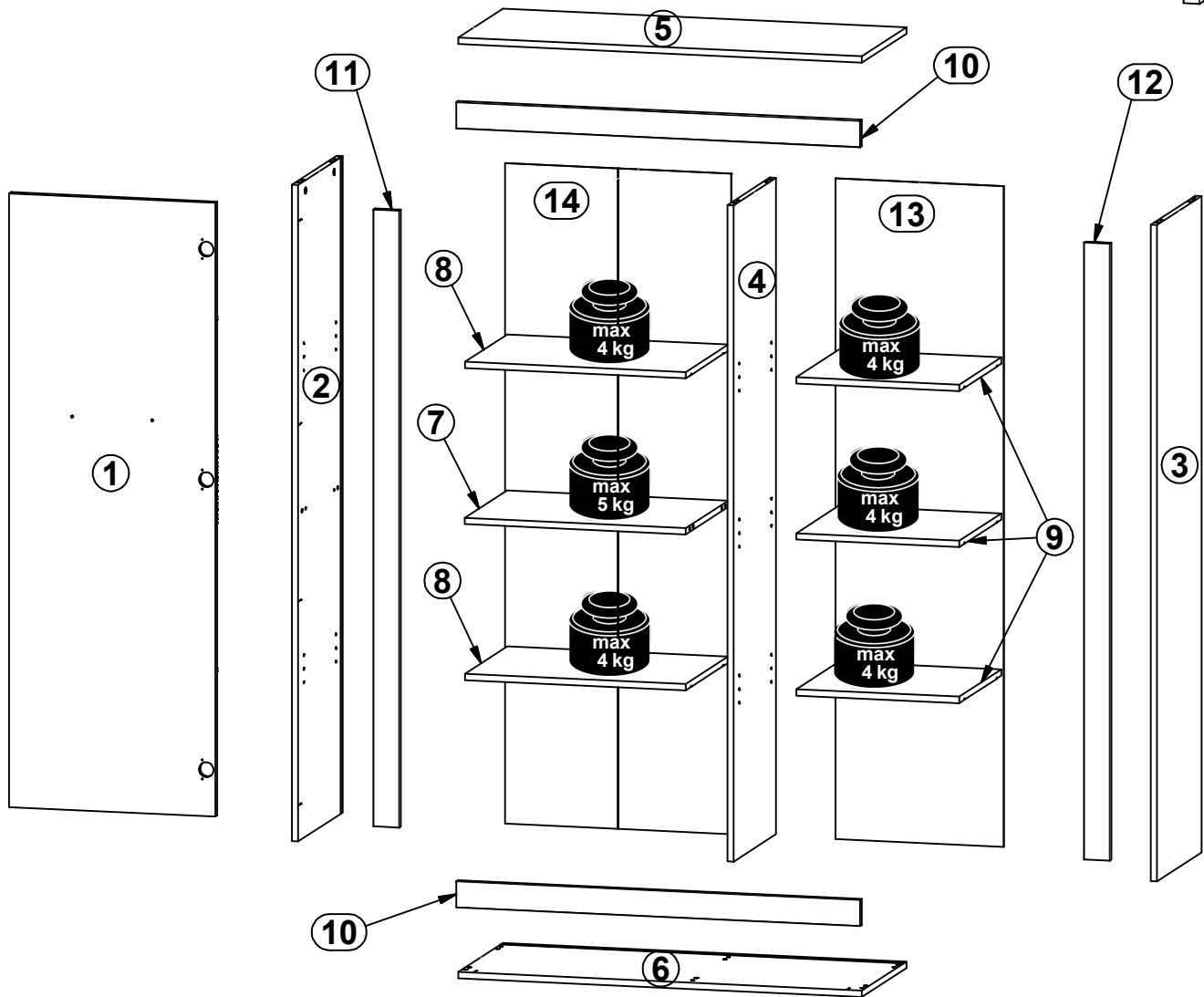

3x a132	1x a133	3x b43	1x c306 192 mm	20x d1 Ø5x17 mm	14x d37	6x e1 Ø7x50 mm	6x e2 Ø6.3x13 mm	16x f1 Ø8x30 mm
2x j30 M4x22 mm	1x k53 Ø50x25 mm	4x k55 60x60/25 mm	12x l2	8x n108 22x9.5x210.7 mm	8x p6 Ø4x35 mm	1x p36 Ø4x25 mm	56x p38 Ø3.5x16 mm	6x p51 Ø3.5x15 mm
10x p55 Ø2.9x16 mm	10x r1 Ø15x12 mm #16	10x r42 20/11	6x s68 Ø 20mm	1x z1 4 mm				
						1x p38 Ø3.5x16 mm	1x n26	

1 

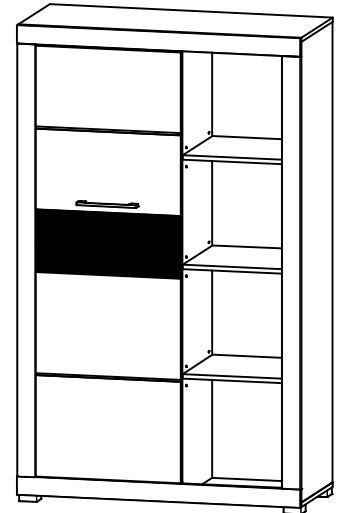
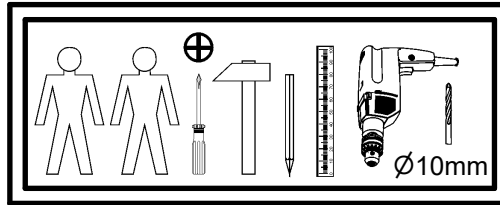
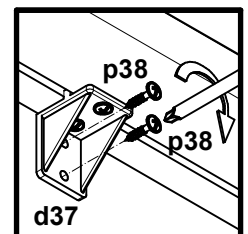
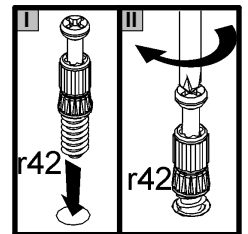
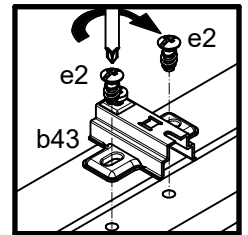
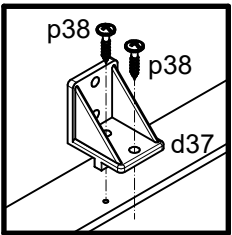
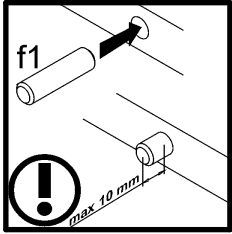
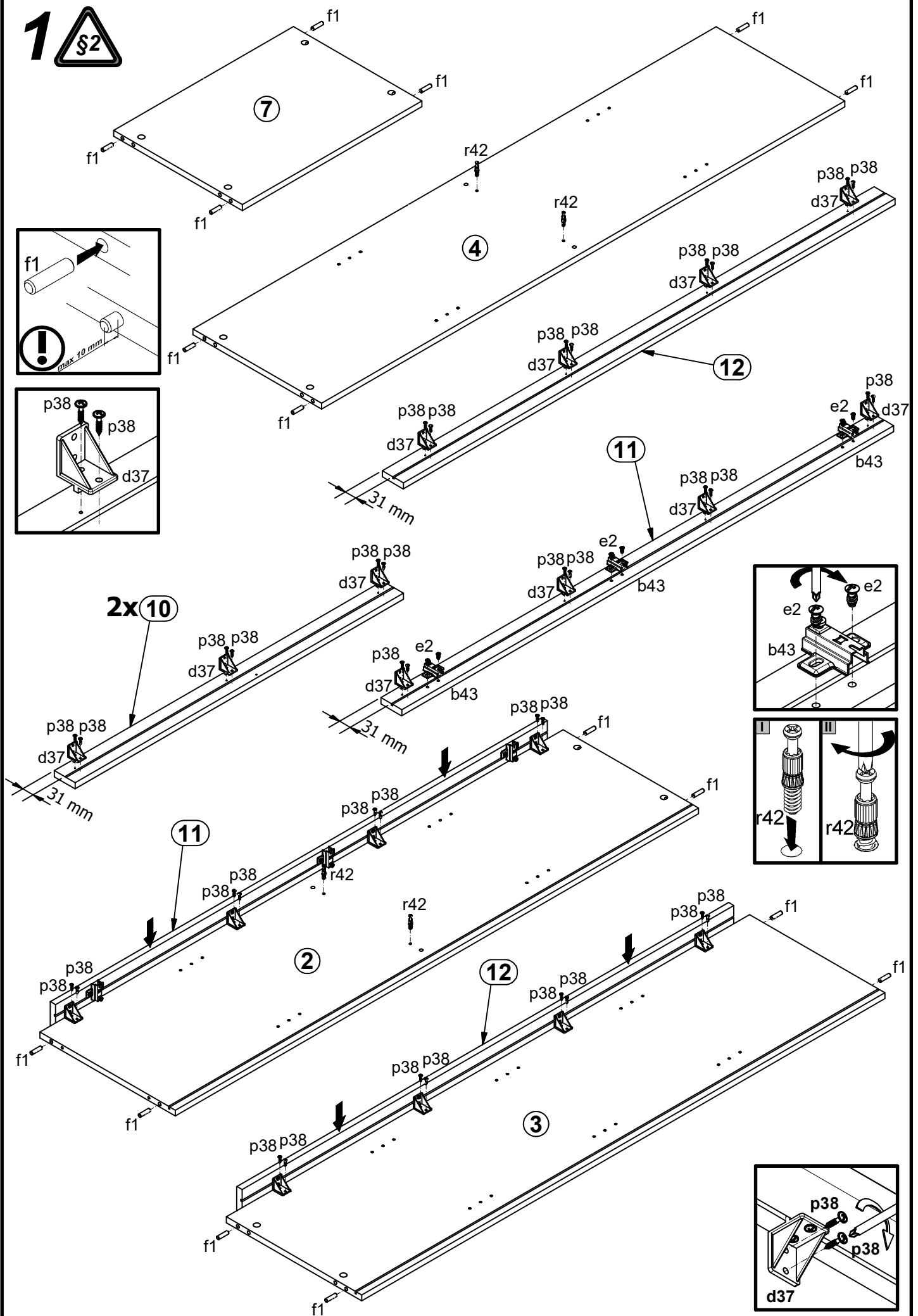

2 

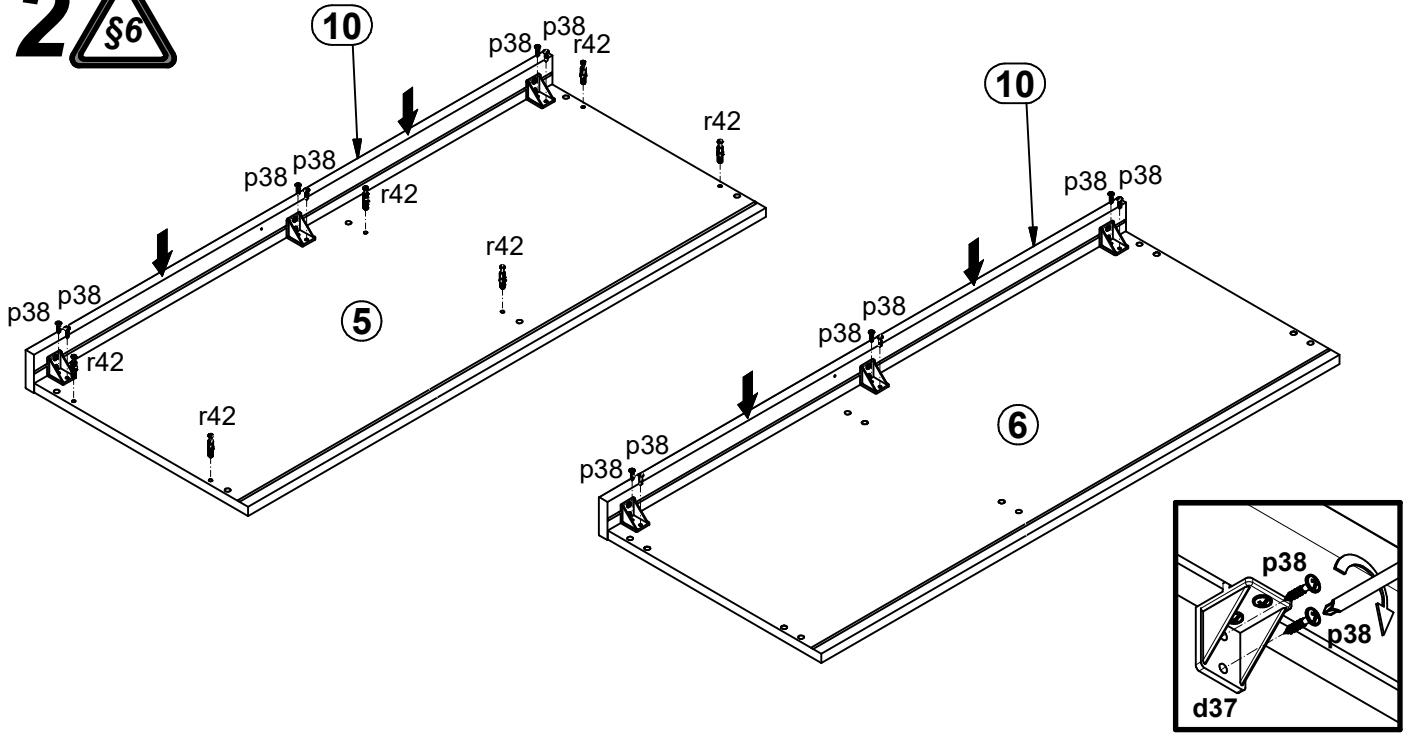

3 

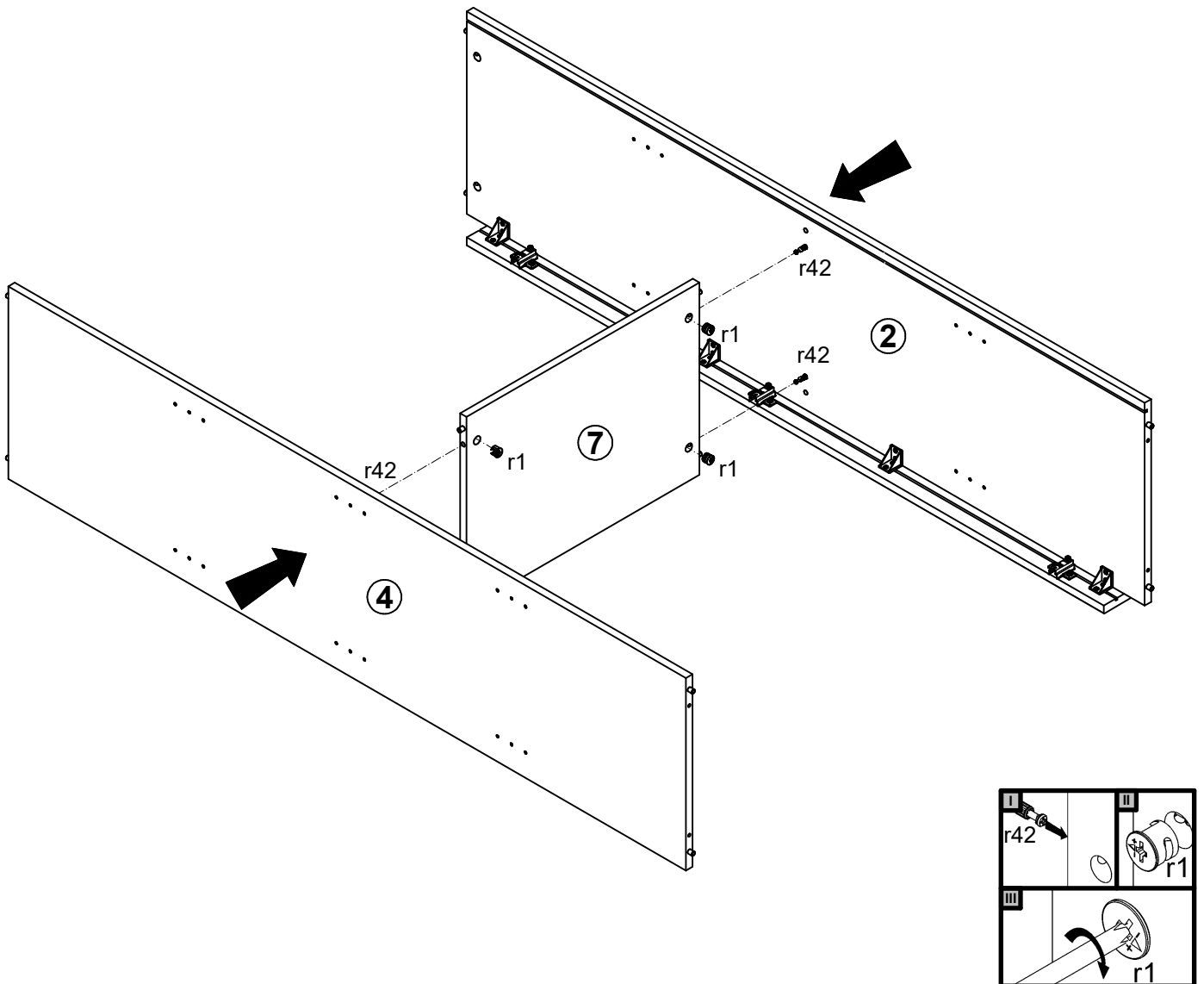

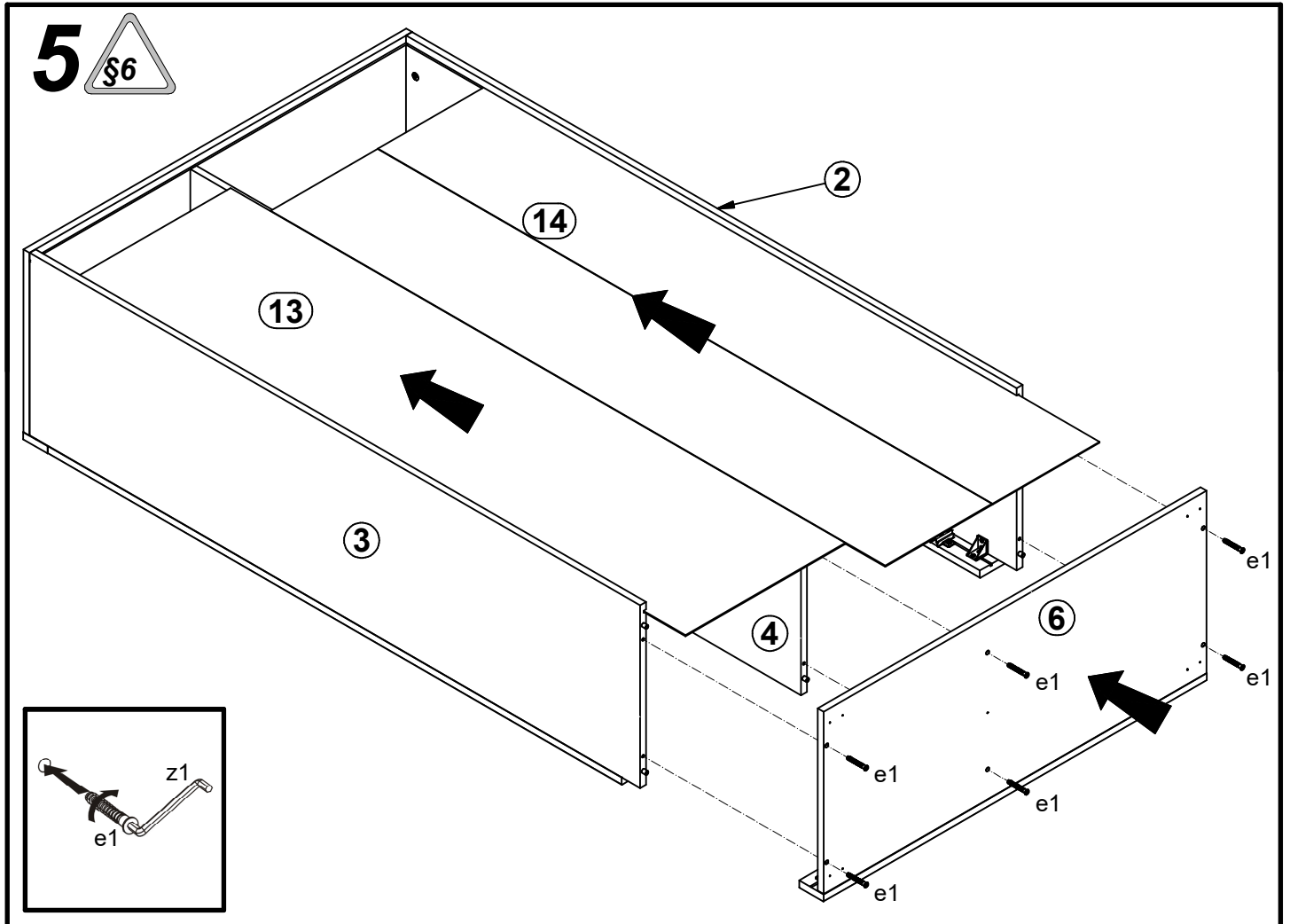
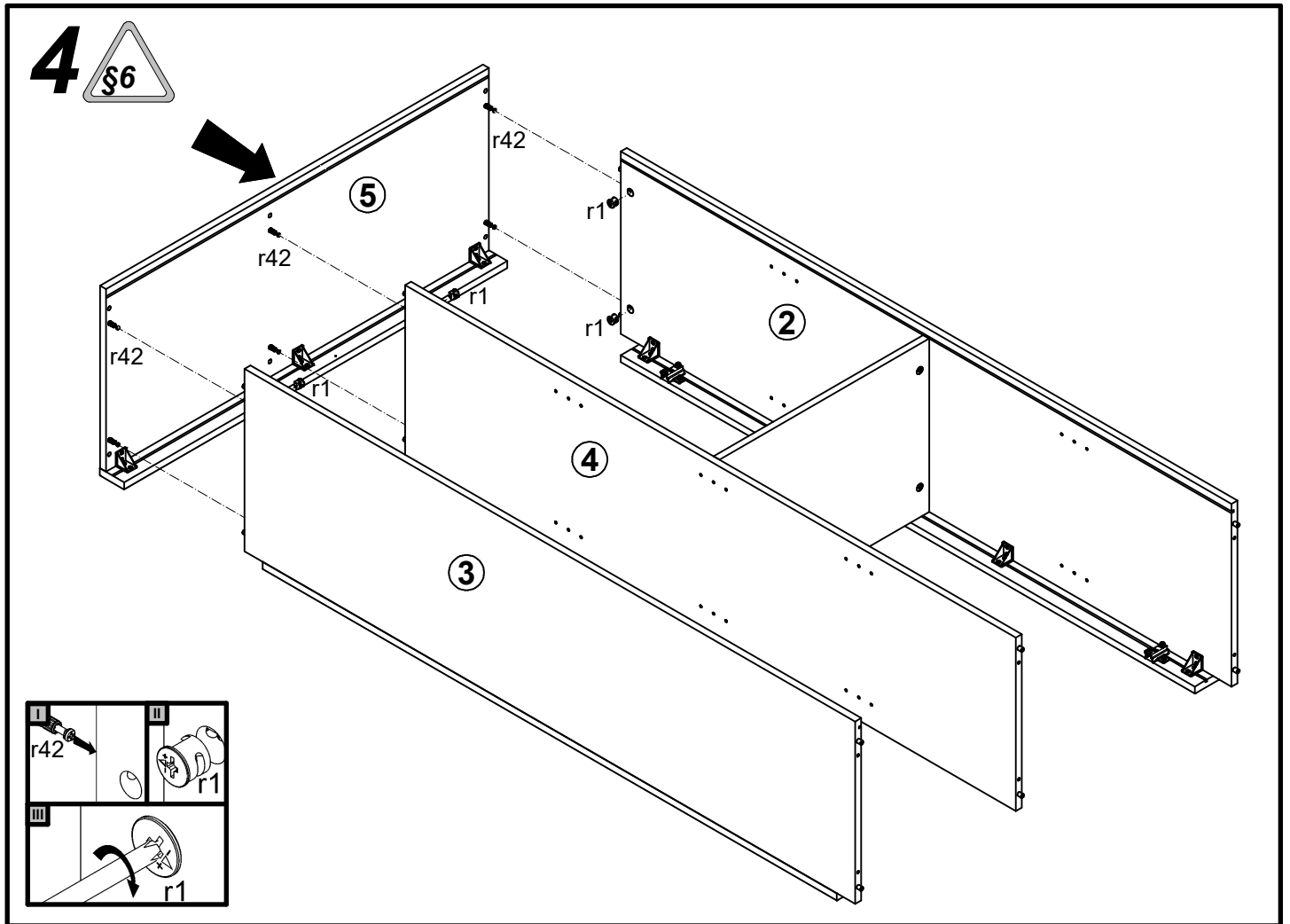

6

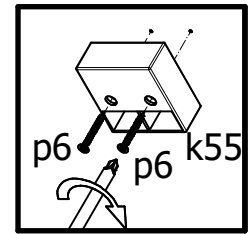
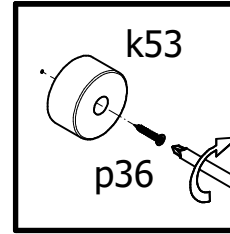
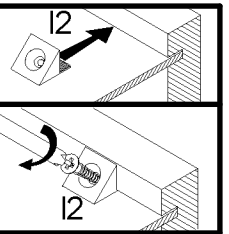
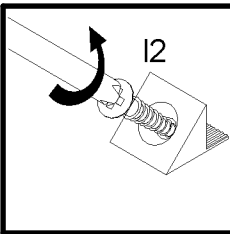
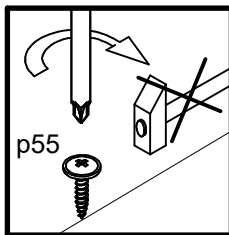
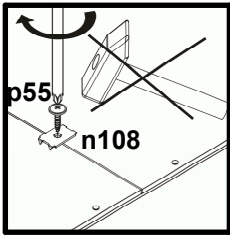
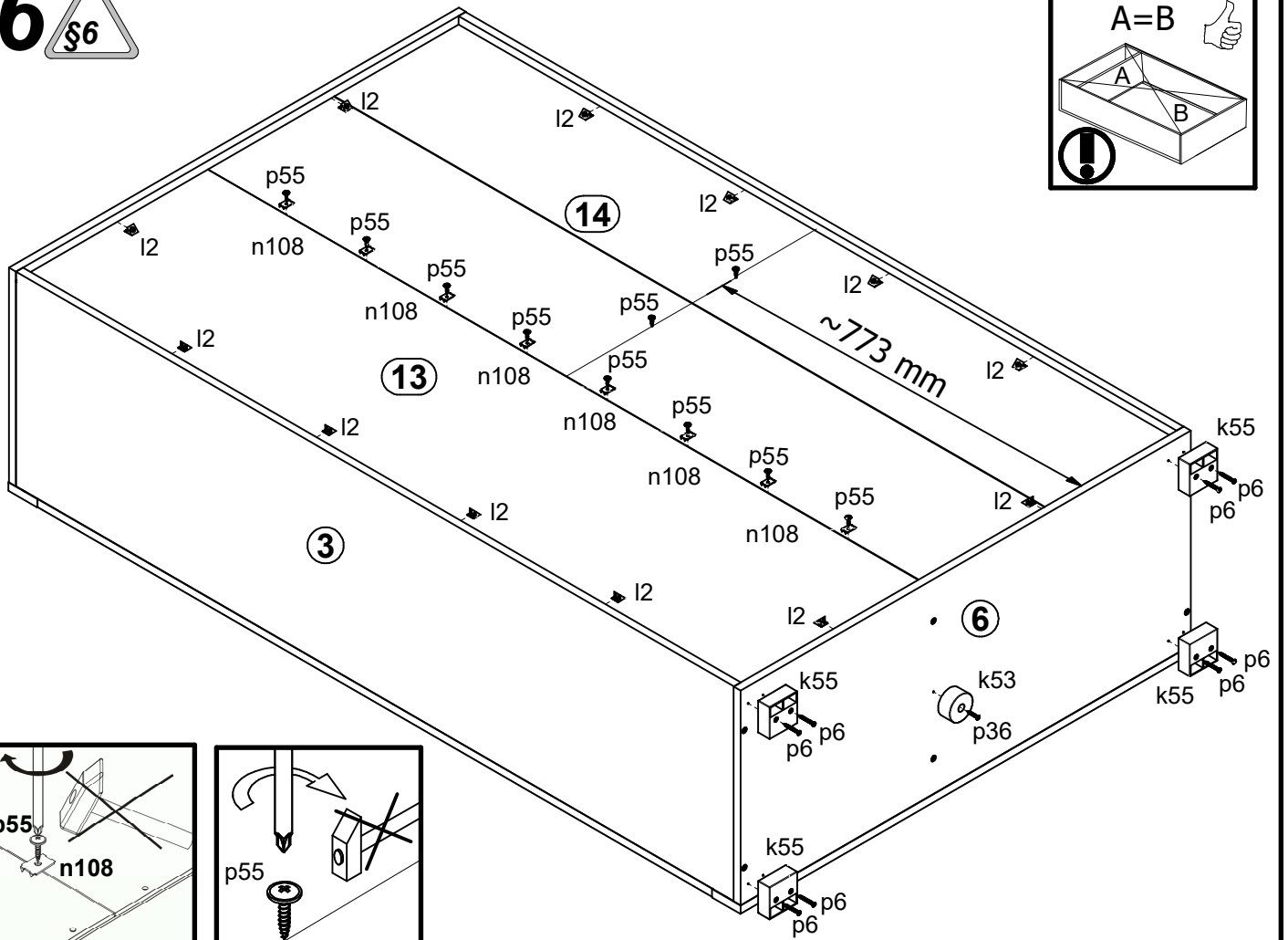
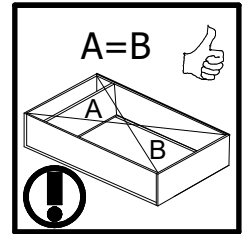

7

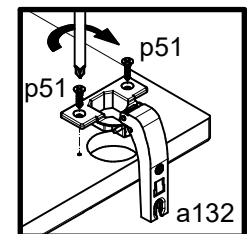
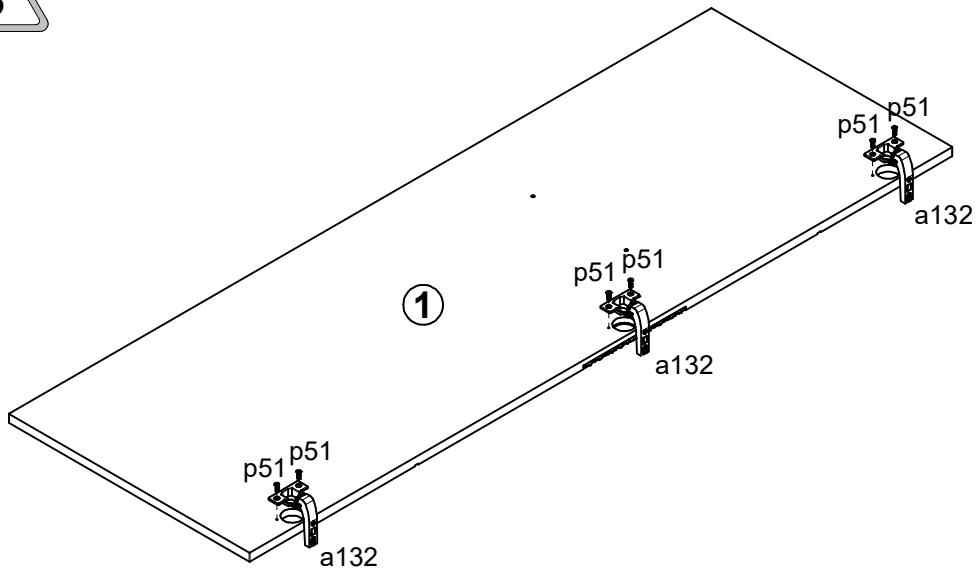

8

