

A	B	C (mm)		D
1	S182-0001	1969	496	3/3
2	S182-1004	1943	540	2/3
3	S182-1005	1943	540	2/3
4	S182-2003	1001	540	1/3
5	S182-2004	1001	540	1/3
6	S182-3004	968,	520	1/3
7	S182-3005	967	510	1/3
8	S182-9302	1953	977	2/3
9	dr-963	963,	30	1/3

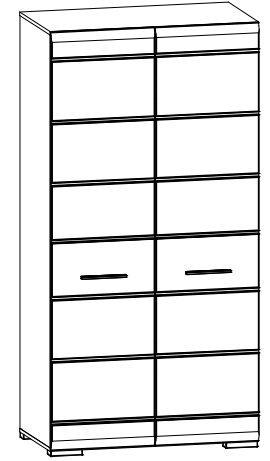

8x a158	8x b43	2x c25318	4x d1 Ø5x17 mm	6x e1 Ø7x50 mm	16x e2 Ø6.3x13 mm	12x f1 Ø8x30 mm	1x k53	2x k54 151x61x25 mm	2x k5511	9x l1	24x l2	2x n158
4x o21 silikon	2x p1 Ø3.5x13 mm	4x p9 Ø4x30 mm	10x p21 Ø4x30 mm	1x p36 Ø4x25 mm	16x p51 Ø3.5x15 mm	6x r1 Ø15x12 mm #16	6x r3 Ø15x15 mm #22	12x r42 20/11	12x s2 Ø16	1x z1		
									2x f35 Ø10x50 mm	2x n1412 86x21x151.5	2x p17 Ø5x60 mm	4x p38 Ø3.5x16 mm

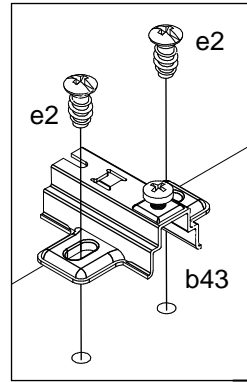
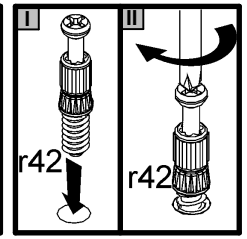
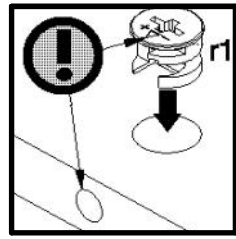
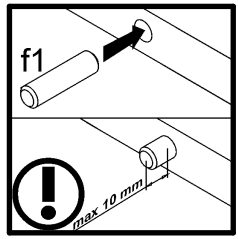
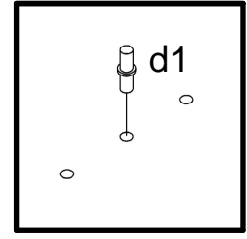
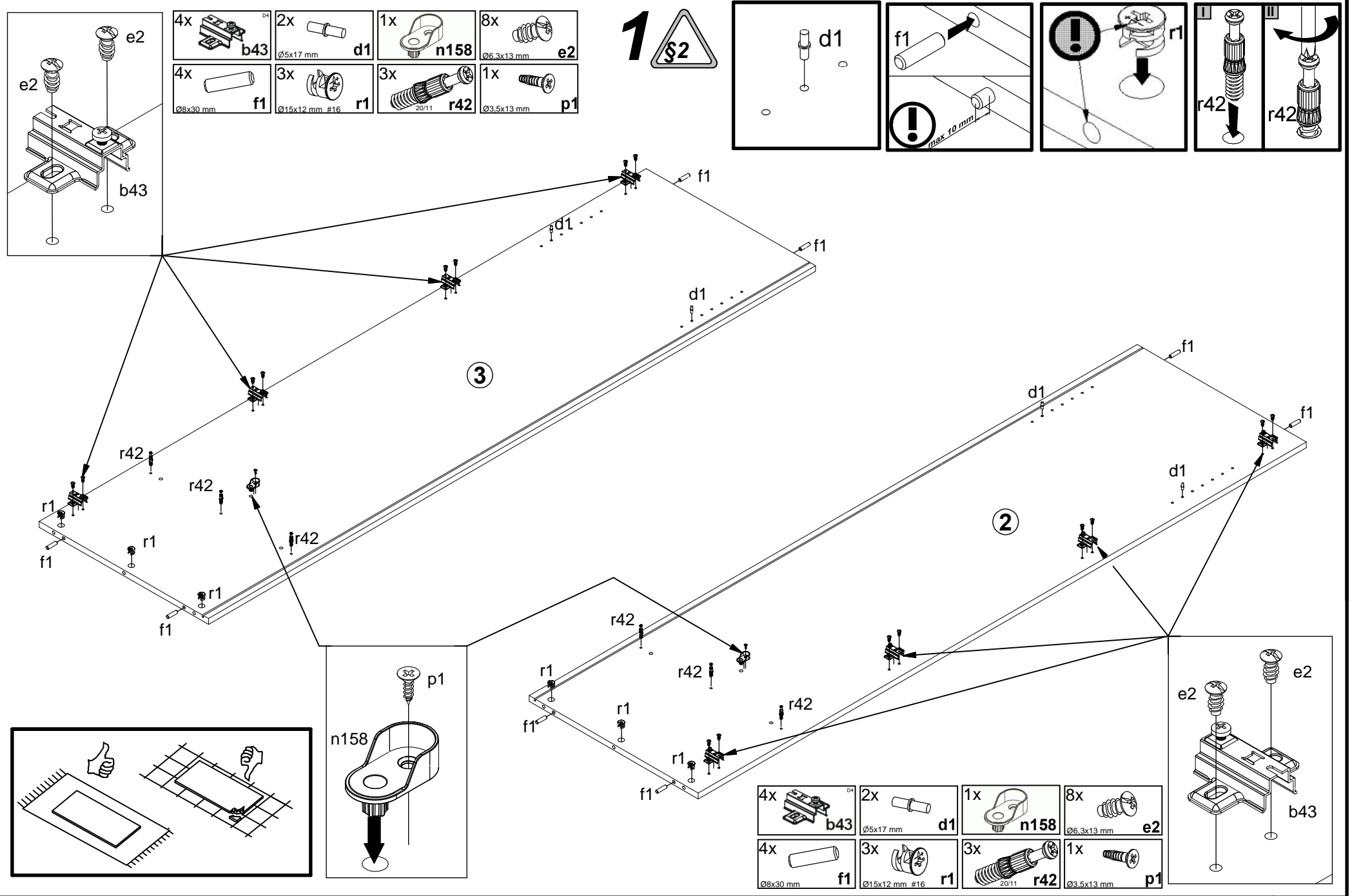

4x b43 Ø4	2x d1 Ø5x17 mm	1x n158	8x e2 Ø6,3x13 mm
4x f1 Ø8x30 mm	3x r1 Ø15x12 mm #16	3x r42 20/11	1x p1 Ø3,5x13 mm

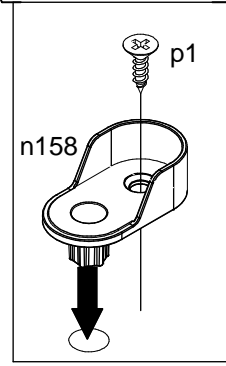
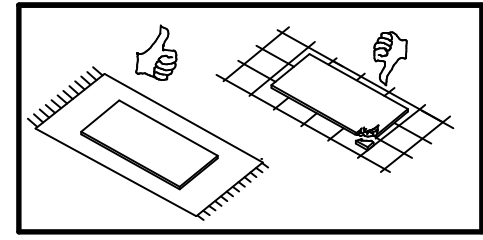

4x b43 Ø4	2x d1 Ø5x17 mm	1x n158	8x e2 Ø6,3x13 mm
4x f1 Ø8x30 mm	3x r1 Ø15x12 mm #16	3x r42 20/11	1x p1 Ø3,5x13 mm

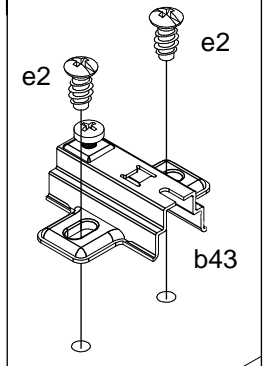

A

S182-SZF2D/20/10

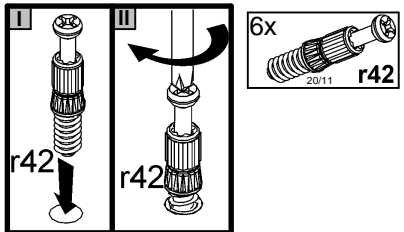

1

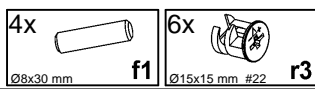
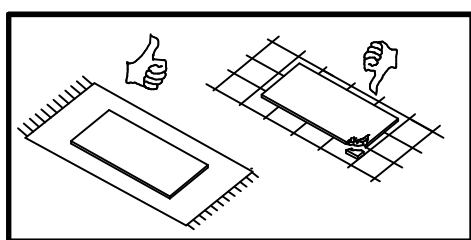
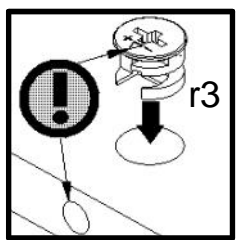
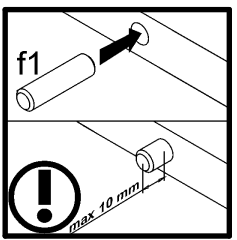
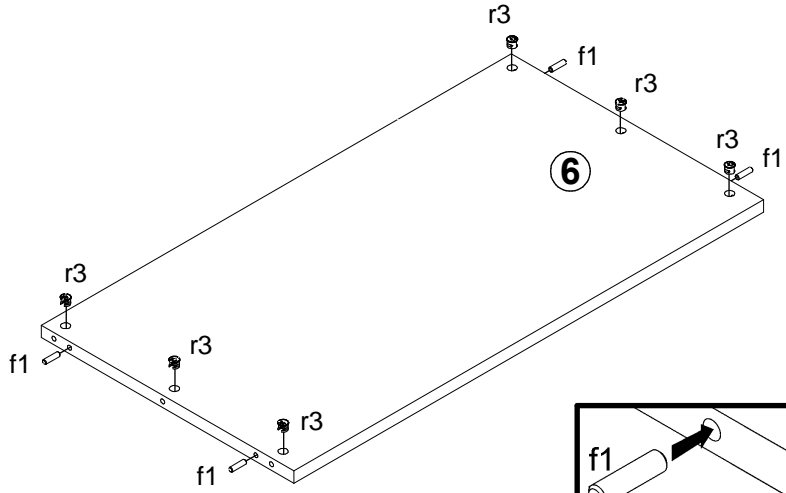
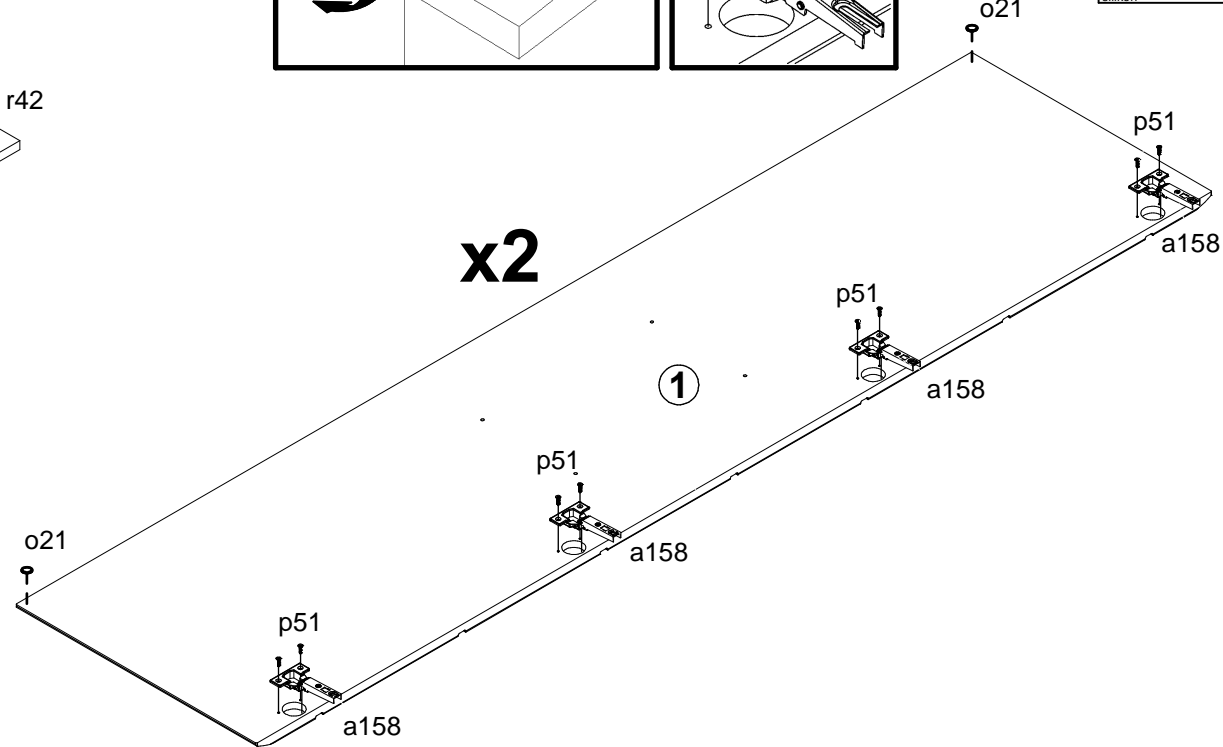
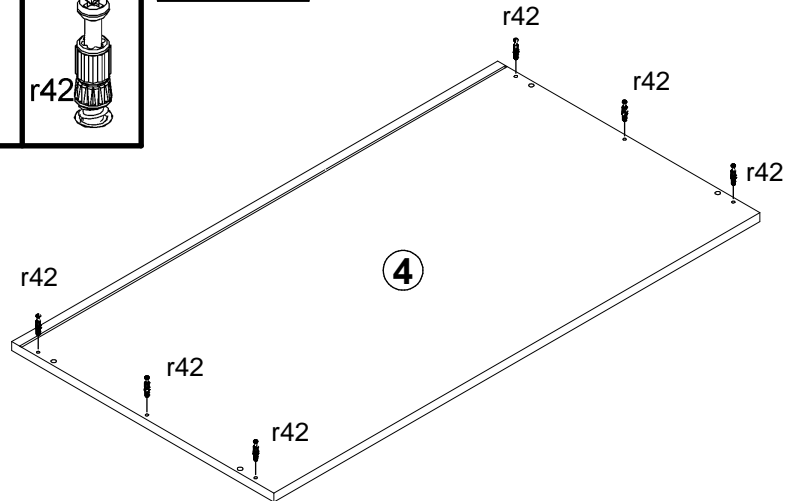
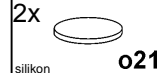
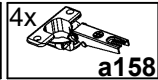
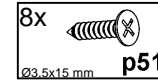
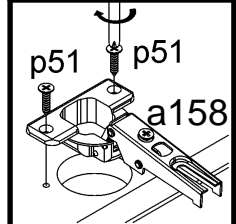
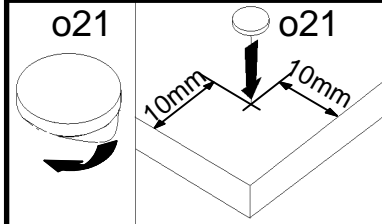



3

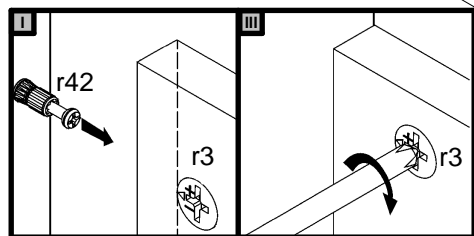
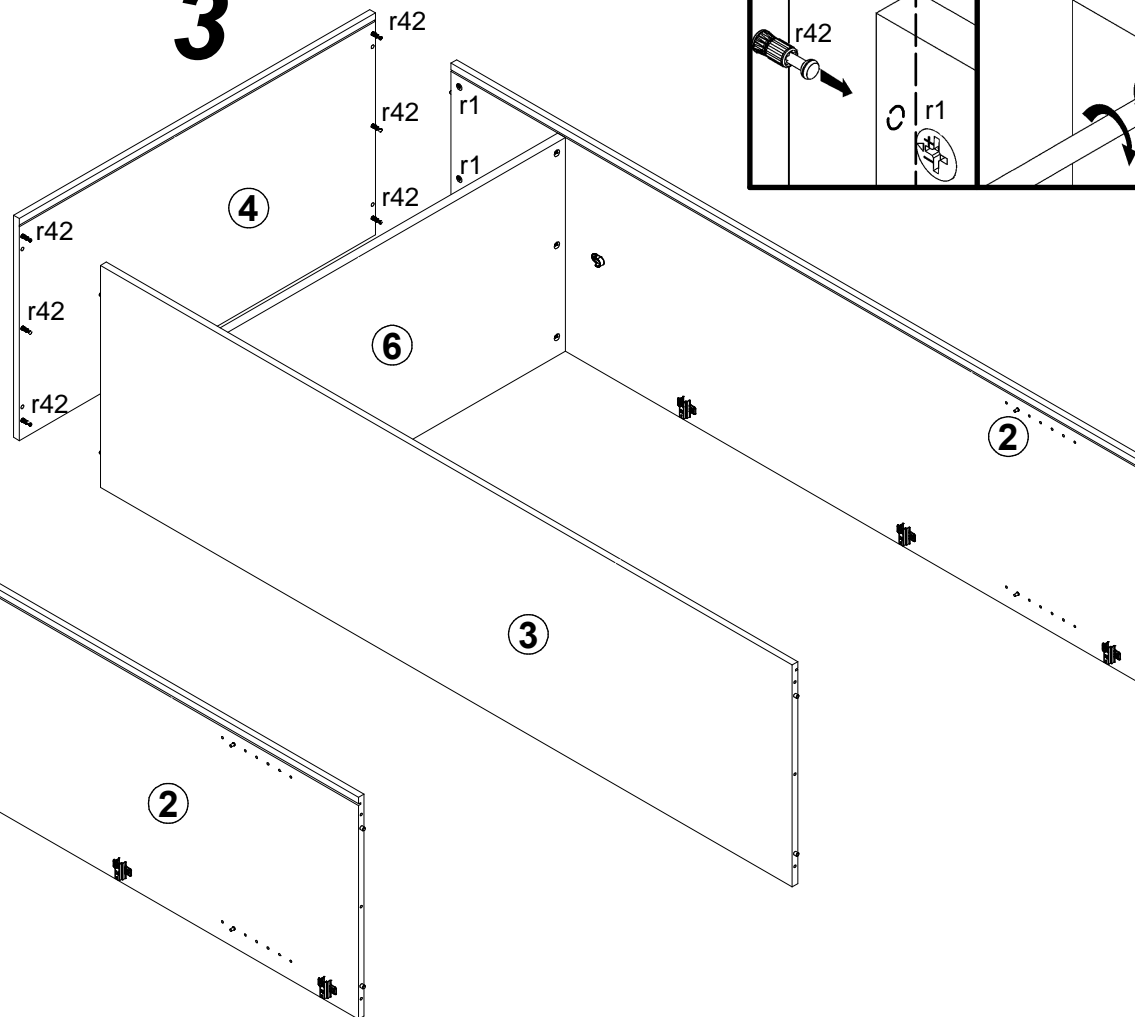
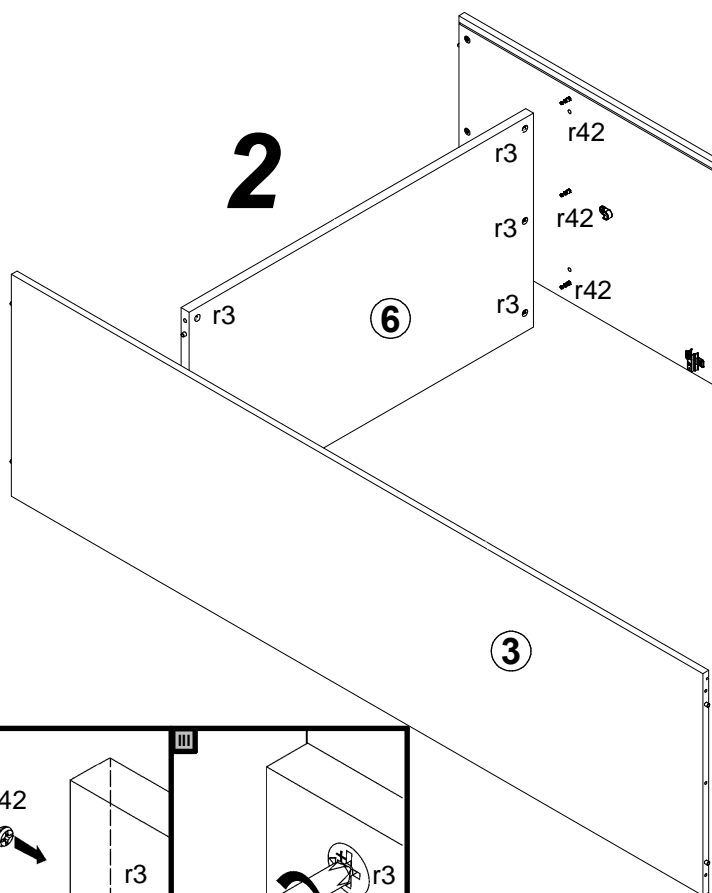
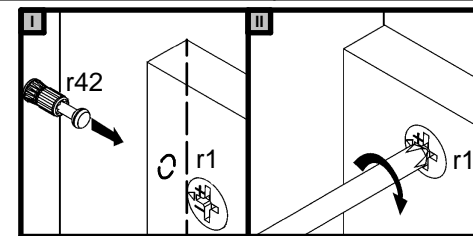

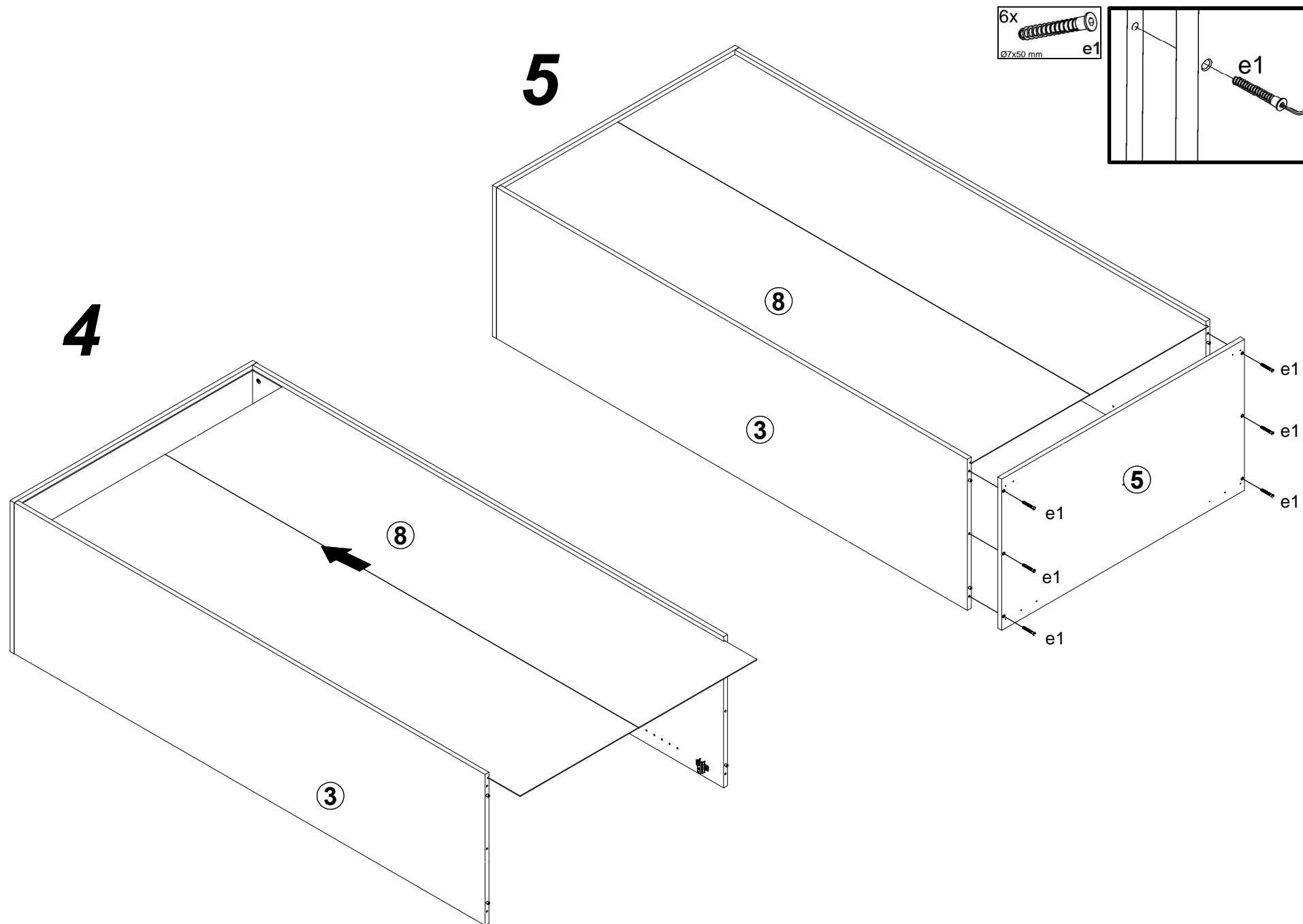

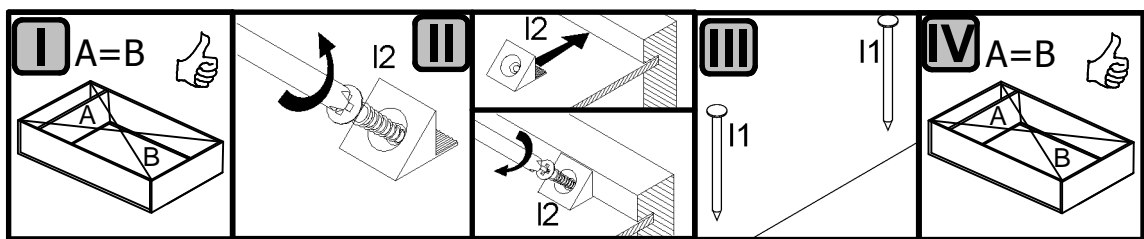

- 1x k53
- 2x k54
151x61x25 mm
- 2x k55\1
- 24x I2
- 9x I1
- 1x p36
Ø4x25 mm
- 10x p21
Ø4x30 mm

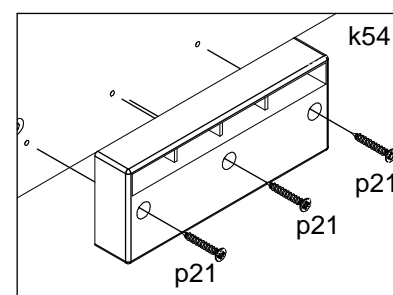
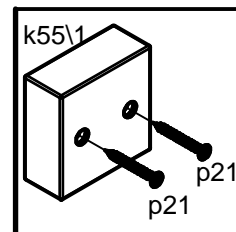
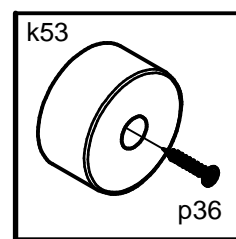
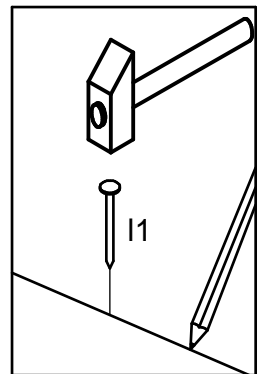
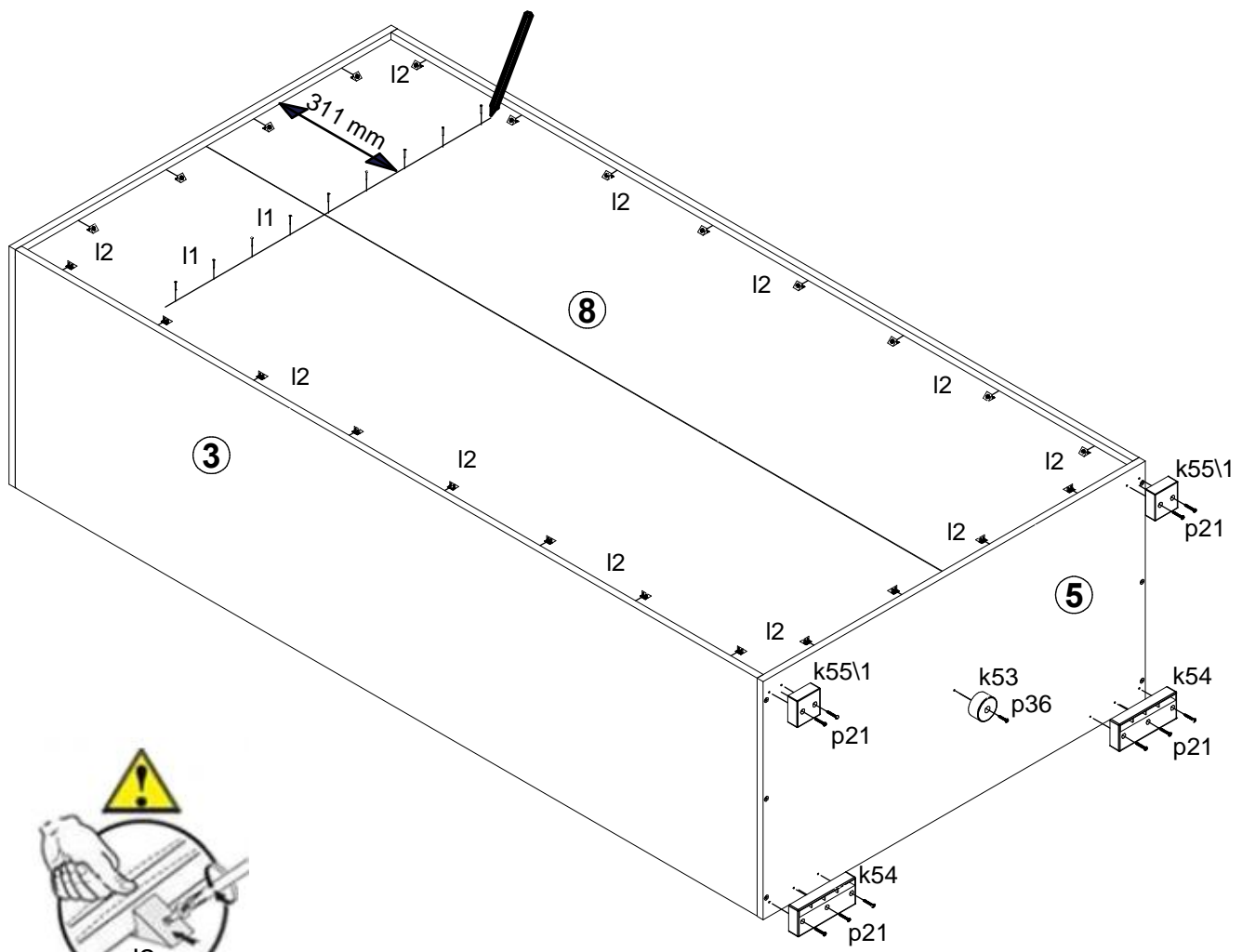

7

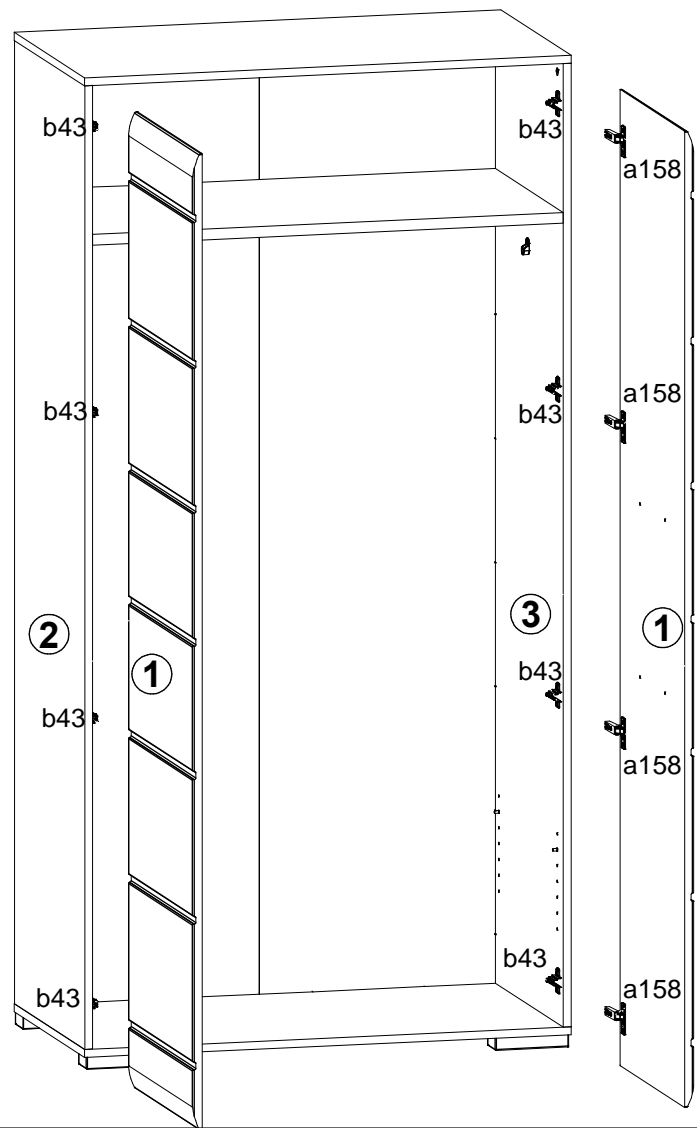
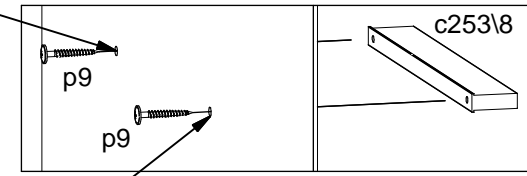
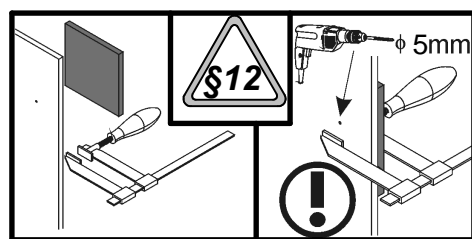
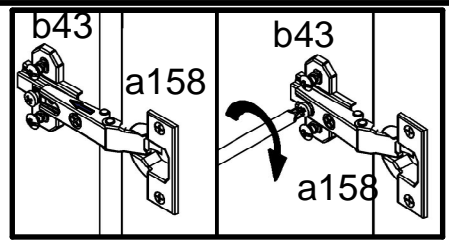

- 4x $\phi 4 \times 30\text{ mm}$ p9
- 2x c253\8
- 12x $\phi 16$ s2

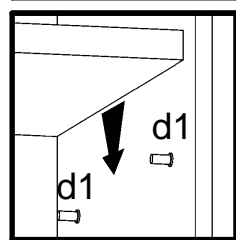
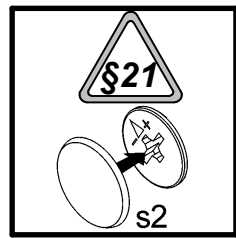

8

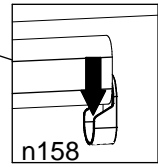
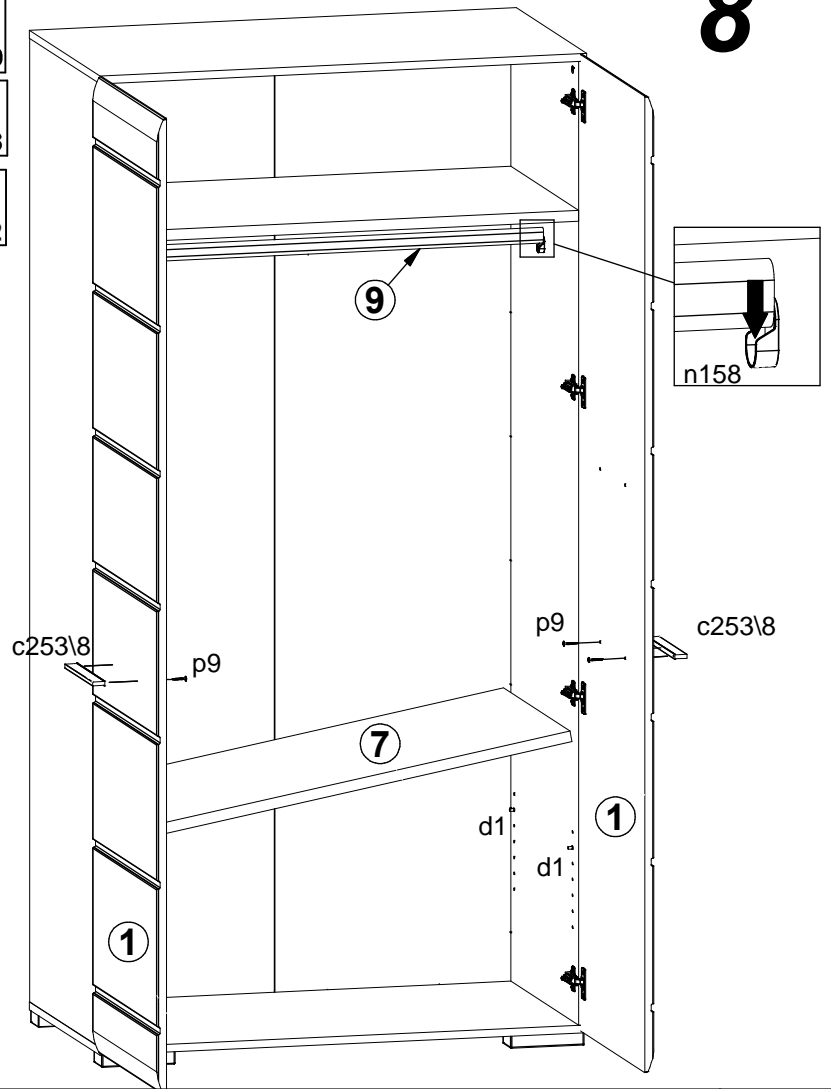

9

