

A	B	C (mm)		D
1	L30-001	2040,	450,	5/5
2	L30-002	2040,	450,	5/5
3	L30-003	2040,	450,	5/5
4	L30-004	2040,	450,	5/5
5	L30-005	2040,	450,	5/5
6	L30-101	2080,	585,	1/5
7	L30-102	2080,	585,	1/5
8	L30-103	2044,	556,	2/5
9	L30-104	2044,	556,	2/5
10	L30-201	2406,	615,	3/5
11	L30-301	2274,	556,	3/5
12	L30-302	902	535	4/5
13	L30-304	438,	535,	4/5
14	L30-305	437,	535,	4/5
15	L30-401	2274,	40,	3/5
16	L30-901-01	2054,	910,	1/5
17	L30-902	2054,	446,	1/5
18	L30-903-01	2054,	910,	1/5
19	dr-897	897	30	4/5

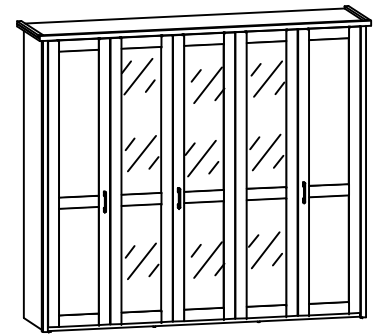

4x  a101	6x  a103	4x  a43	6x  a68	cm 0 1 2 3 4 5 6 7 8 9 10						10x  b35	10x  b59
3x  128 mm c406	12x  Ø5x17 mm d1	4x  Ø7x28 mm e22	16x  Ø8x30 mm f1	8x  M4x25 mm j8	8x  k1	2x  M6/Ø14x14 mm k392	2x  M6/22 mm k393	58x  l2	4x  n158	4x  Ø3,5x13 mm p1	
40x  Ø3,5x15 mm p51	24x  Ø15x12 mm #16 r1	18x  Ø20x12 mm #16 r36	18x  r37	24x  r42	1x  z1	4x  s1	24x  Ø16 s2	5x  d20	5x  Ø6,3x13 mm e2	8x  Ø5x17 mm d1	



1 §2

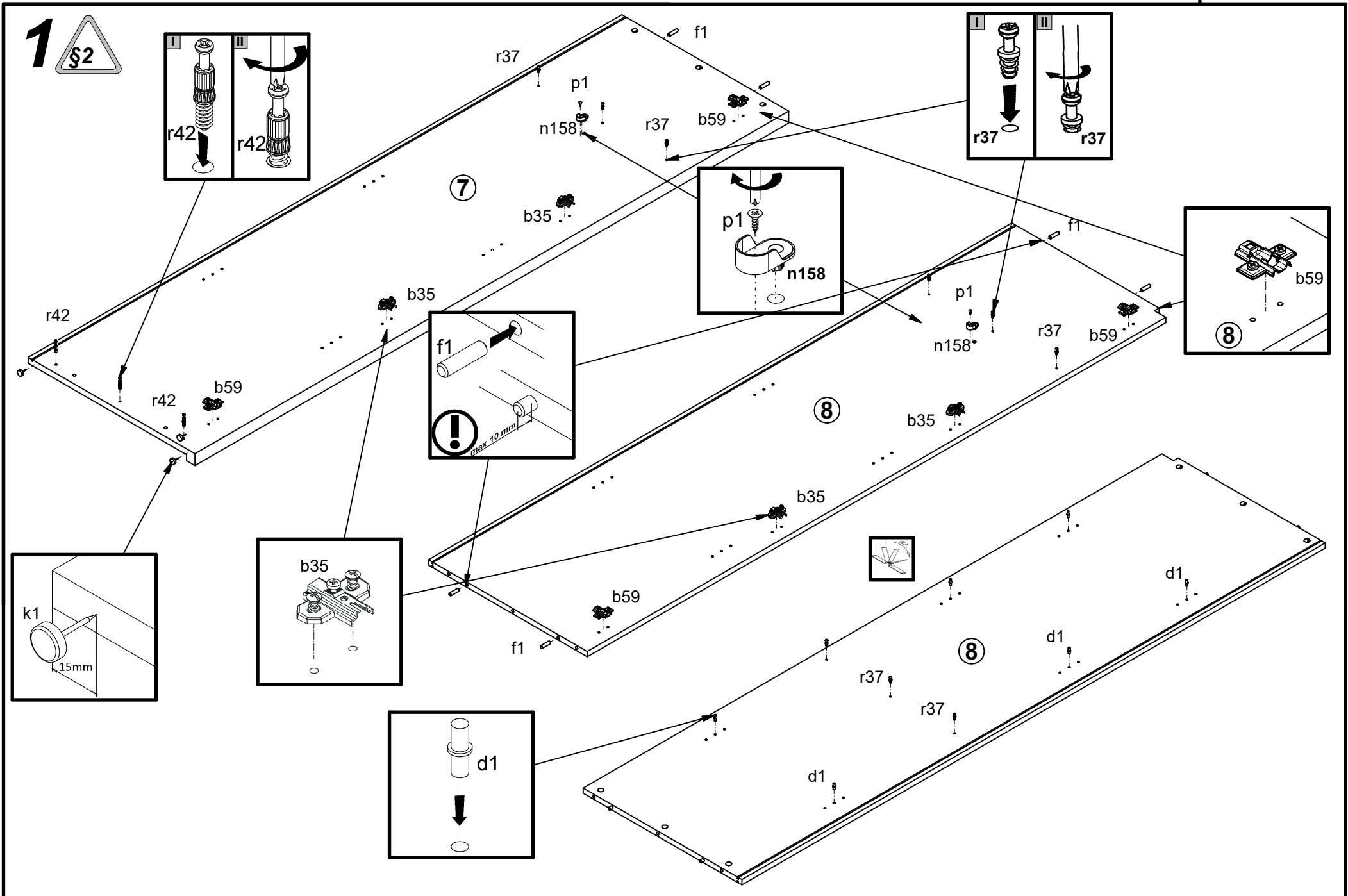
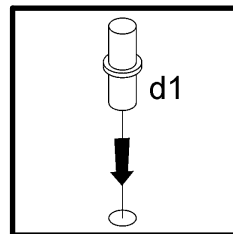
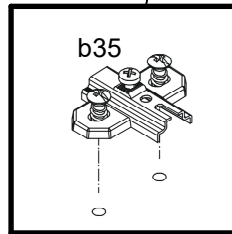
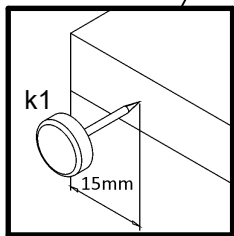
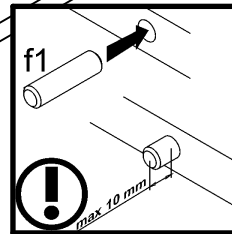
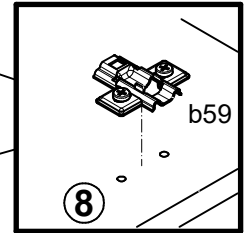
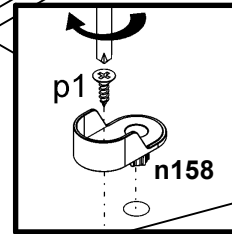
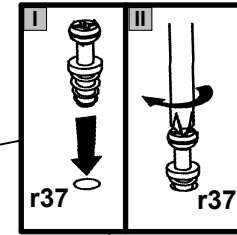
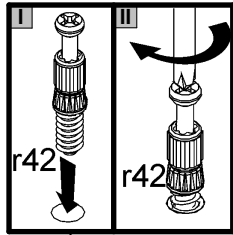

2

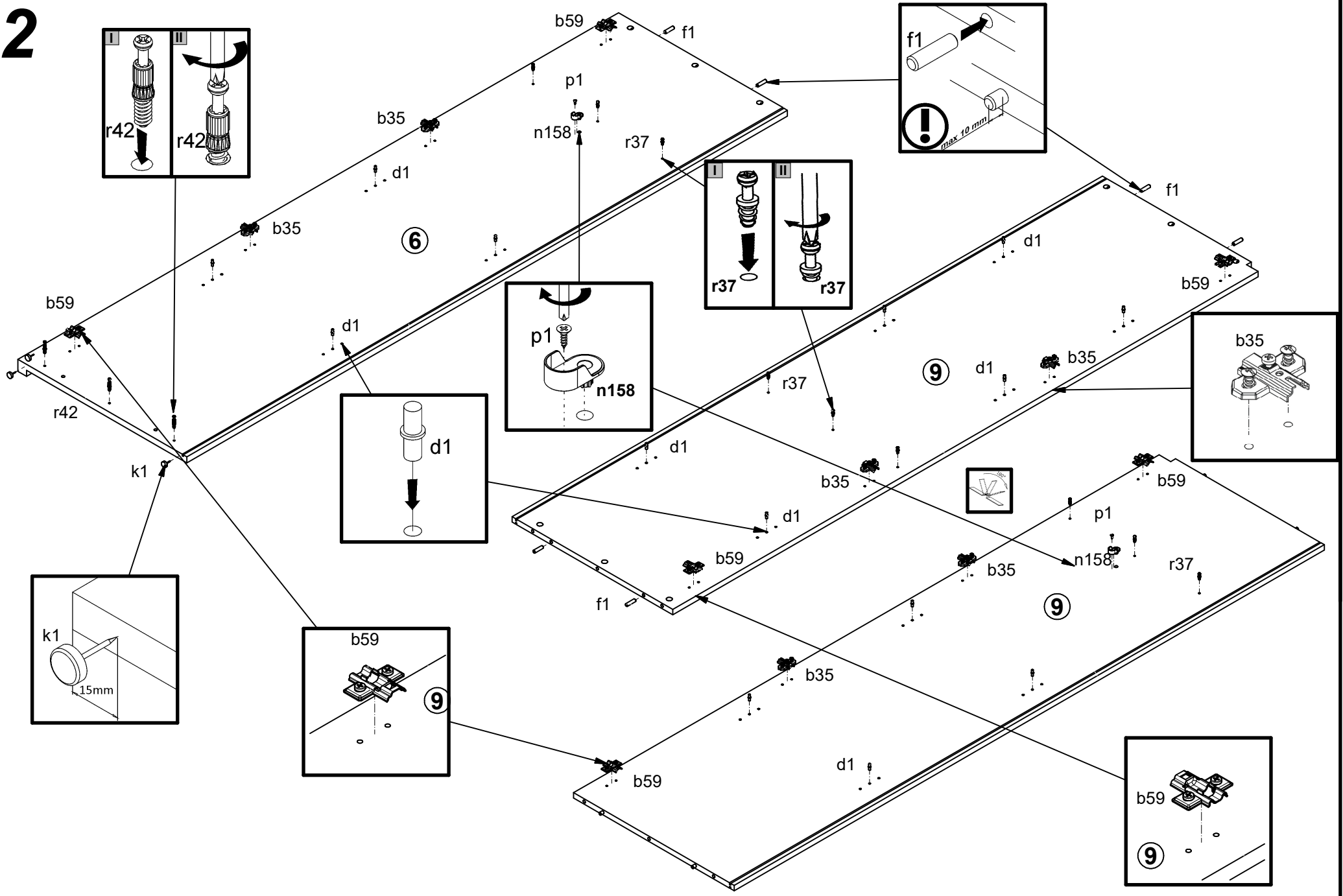

3

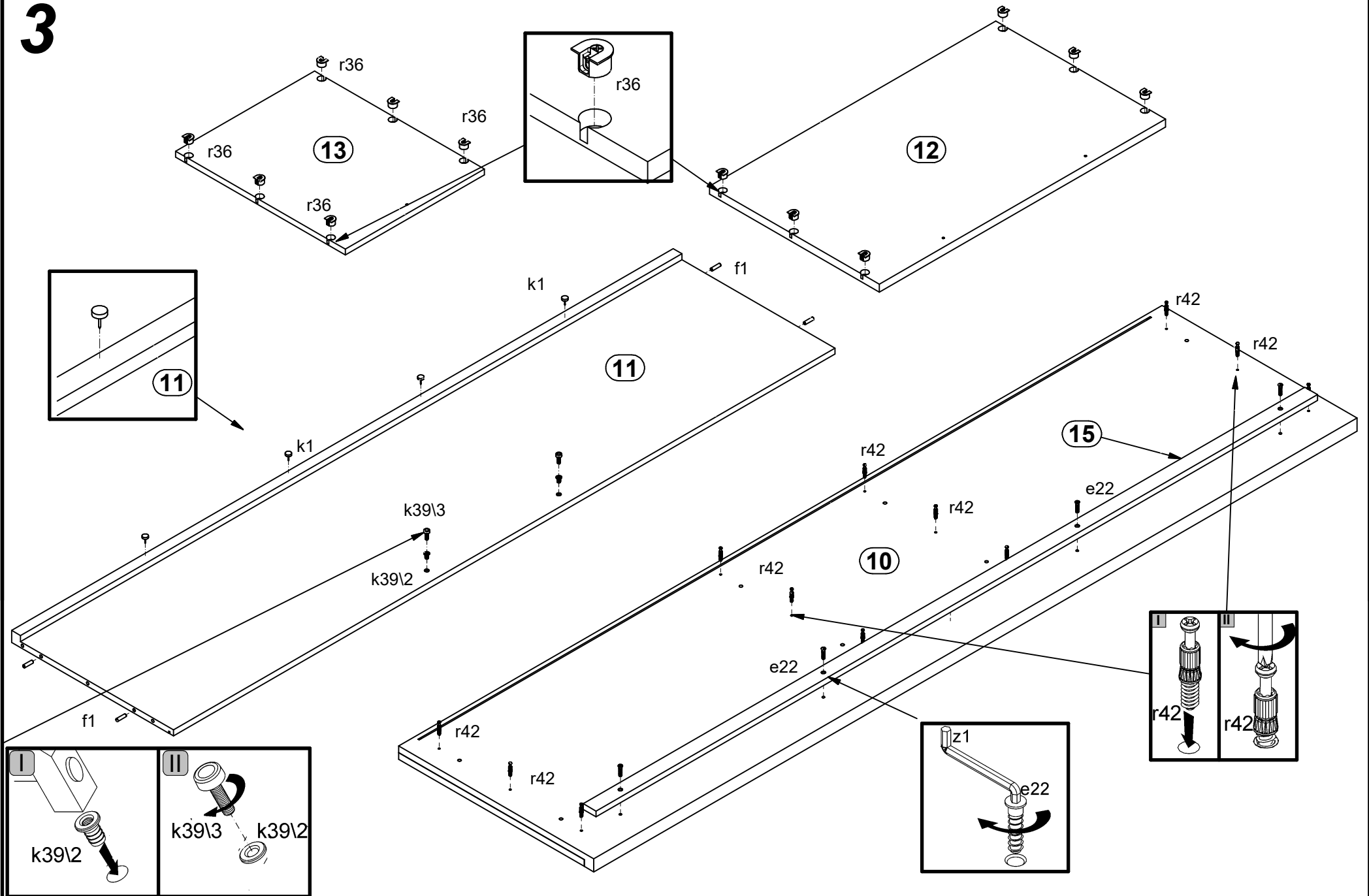

4  

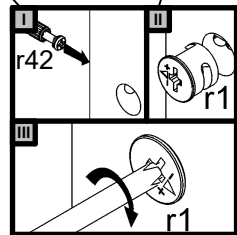
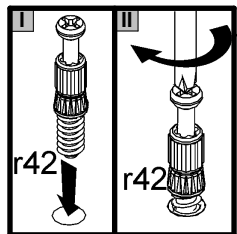
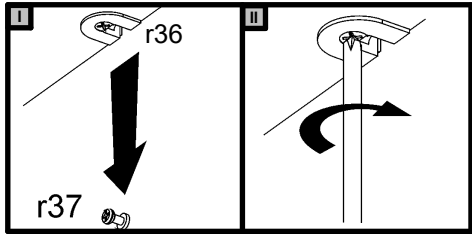
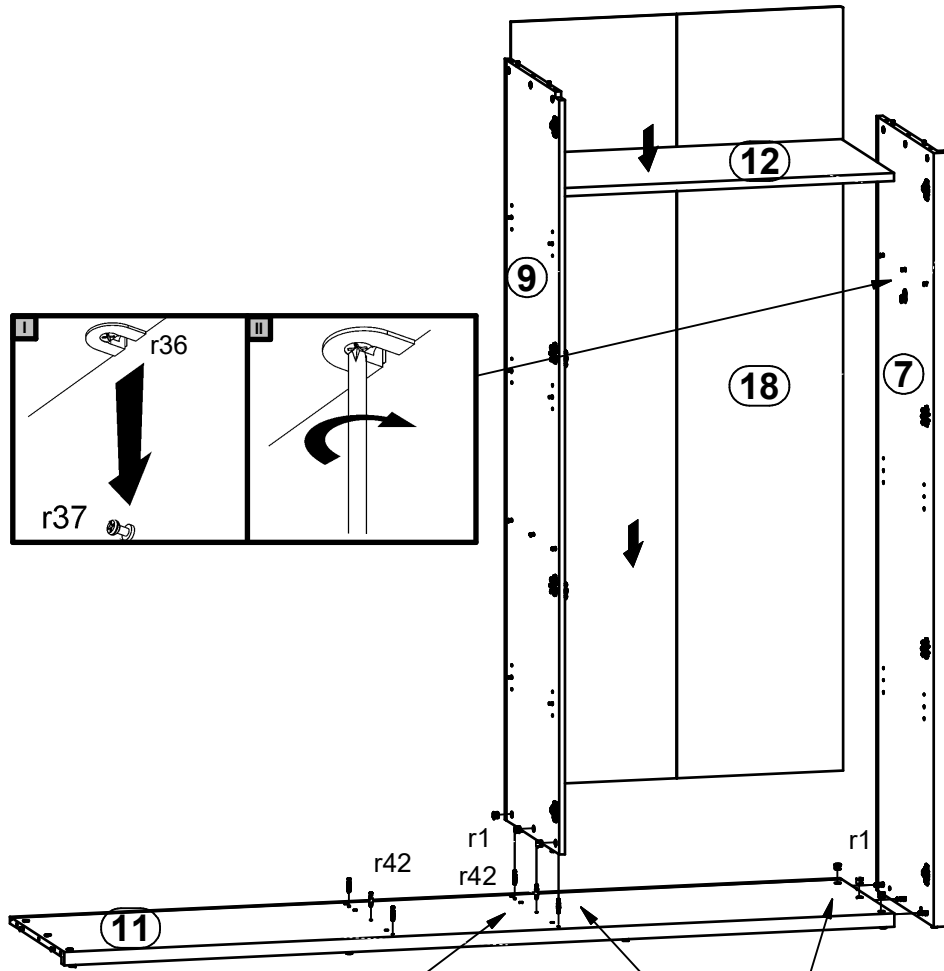

5 

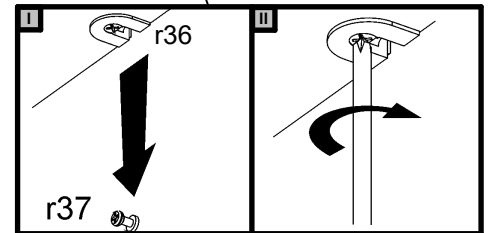
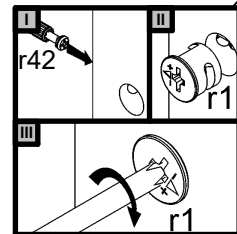
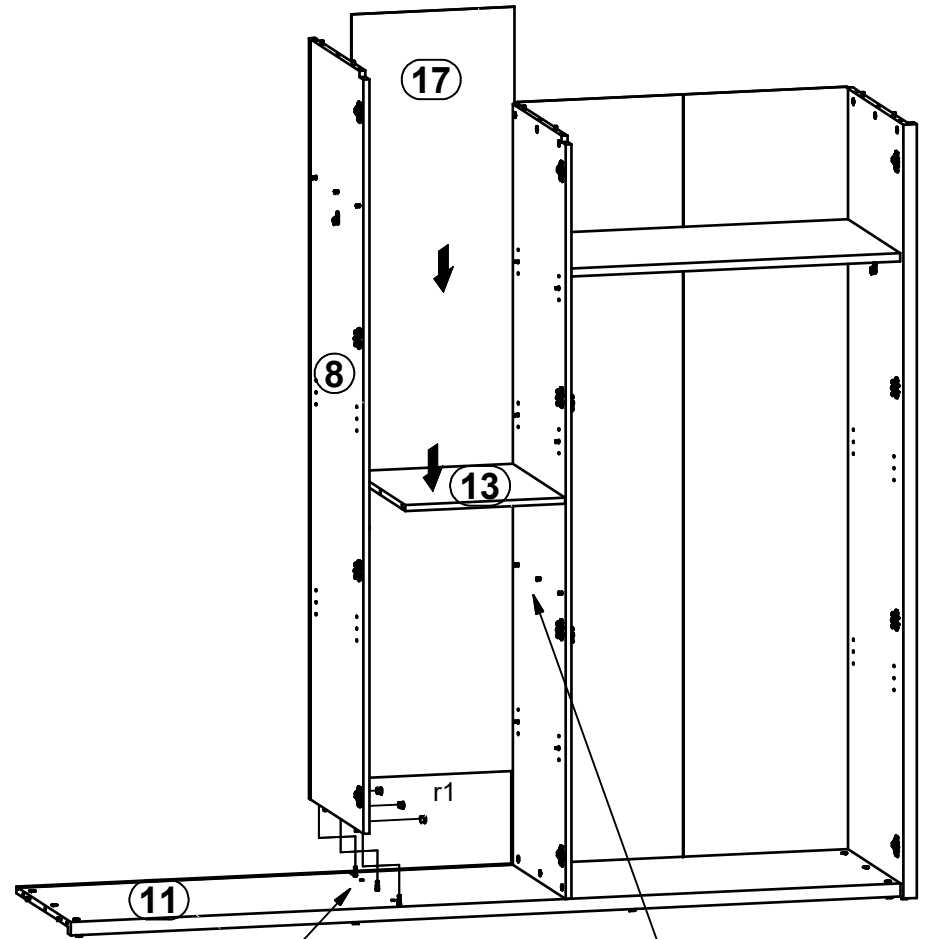

6

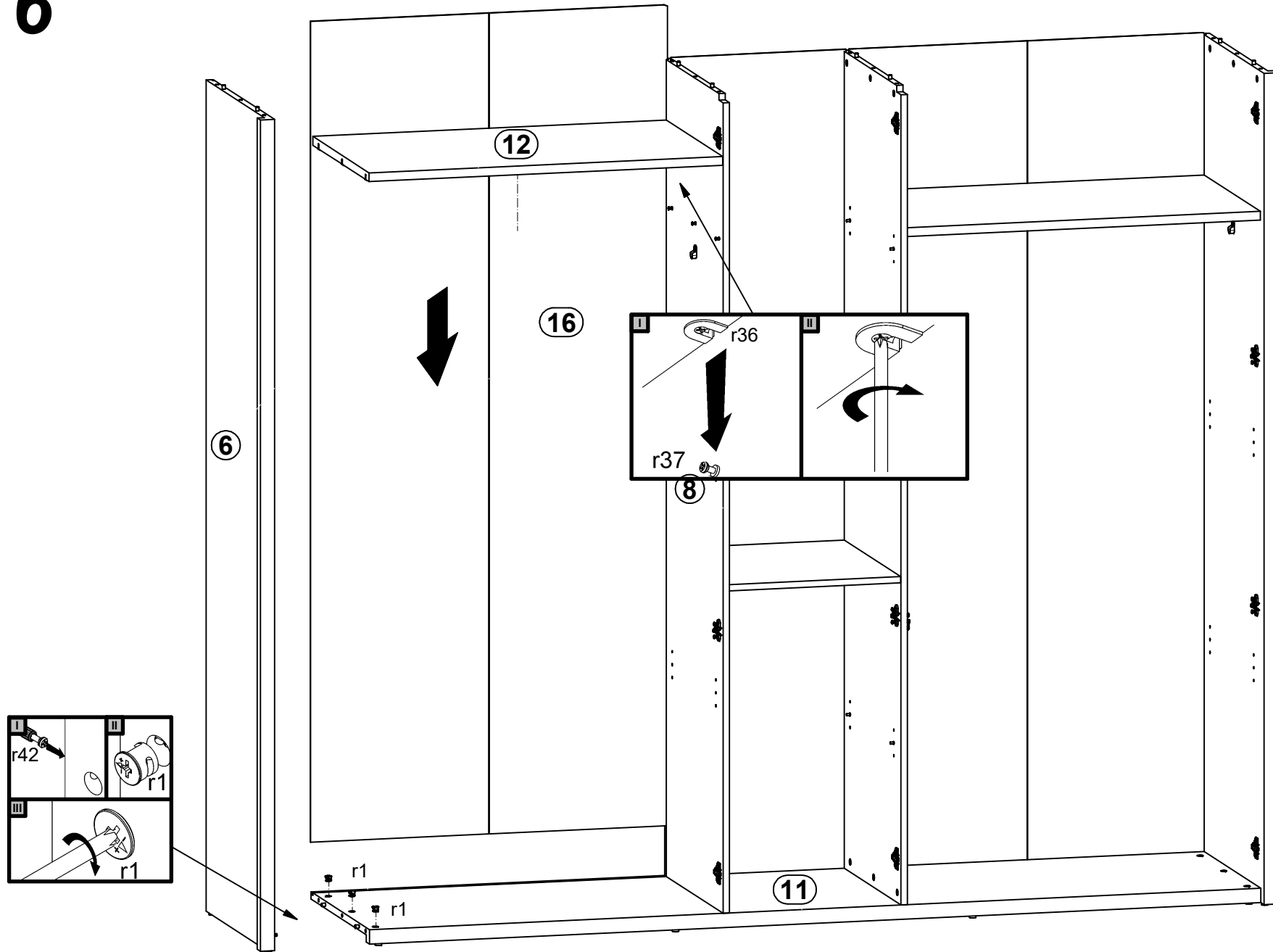

7

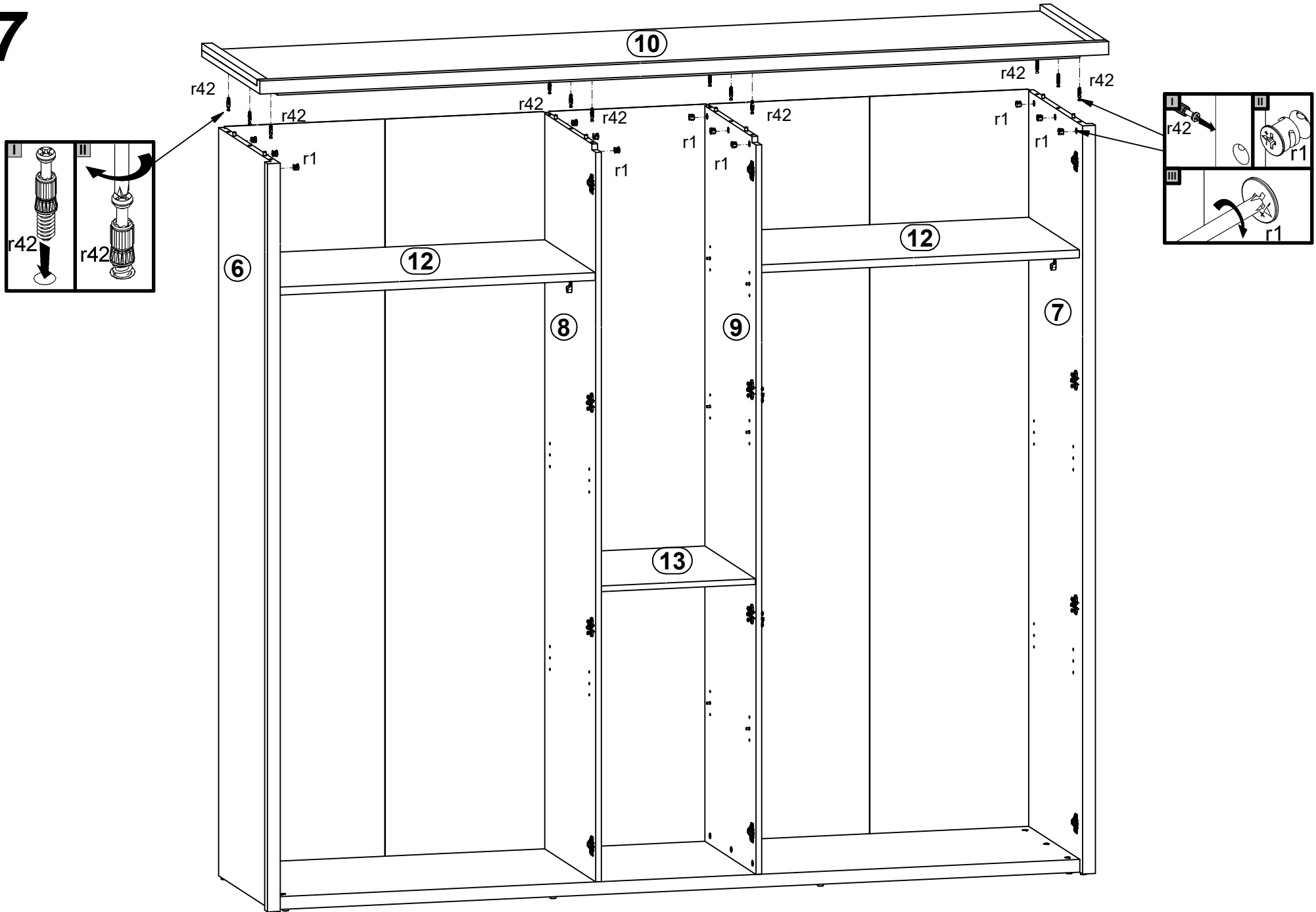



8

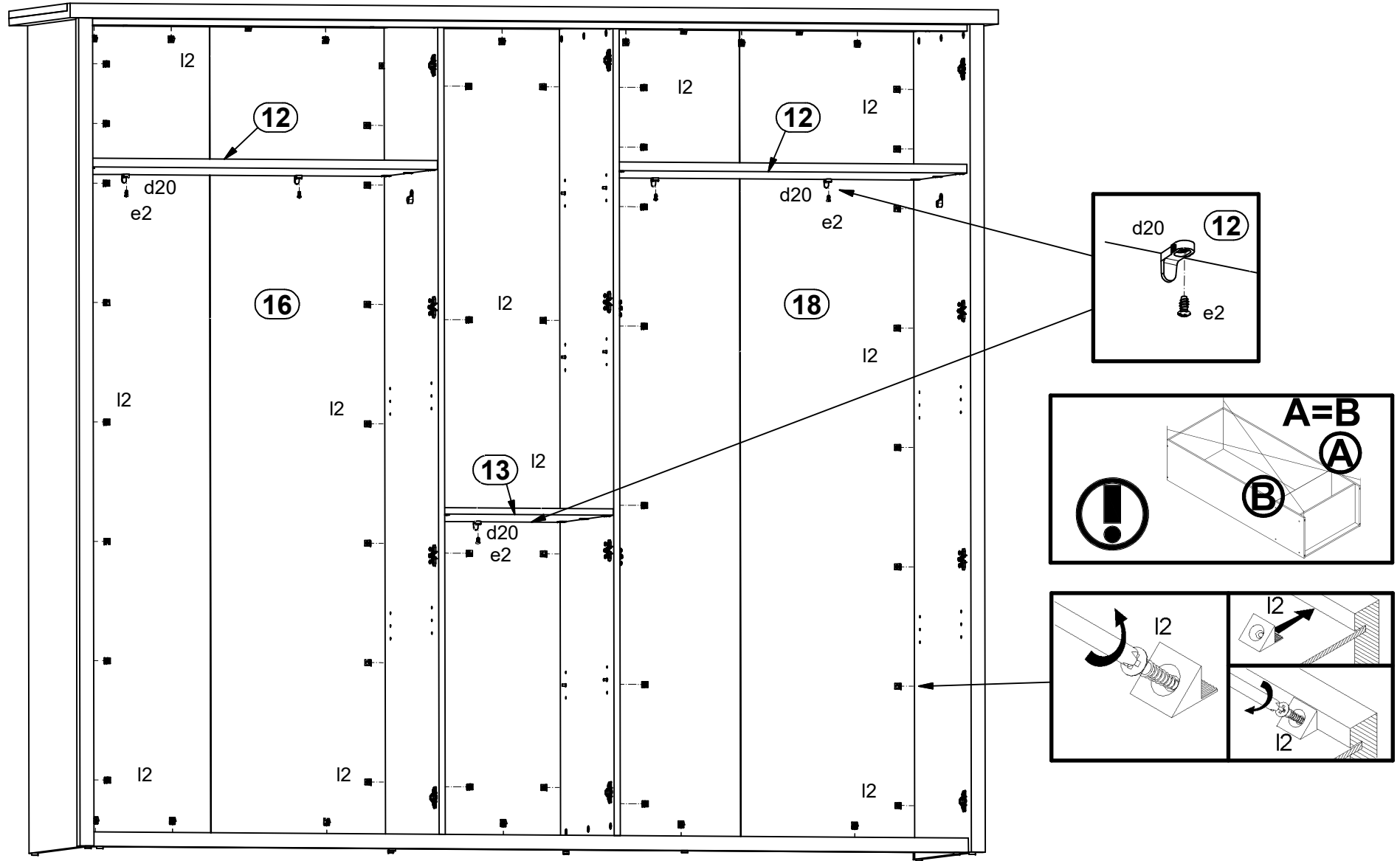

# 9

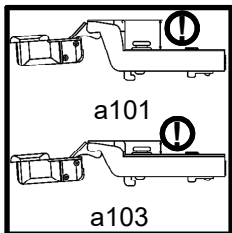
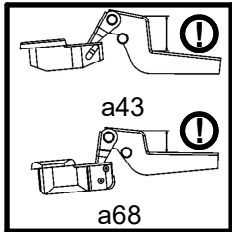
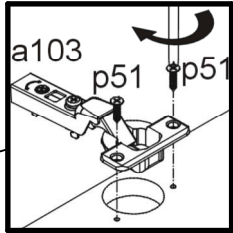
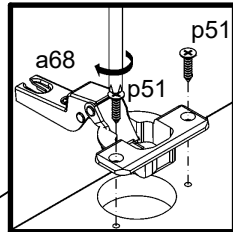
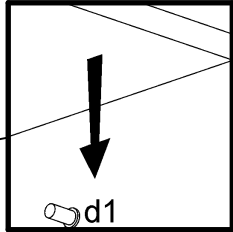
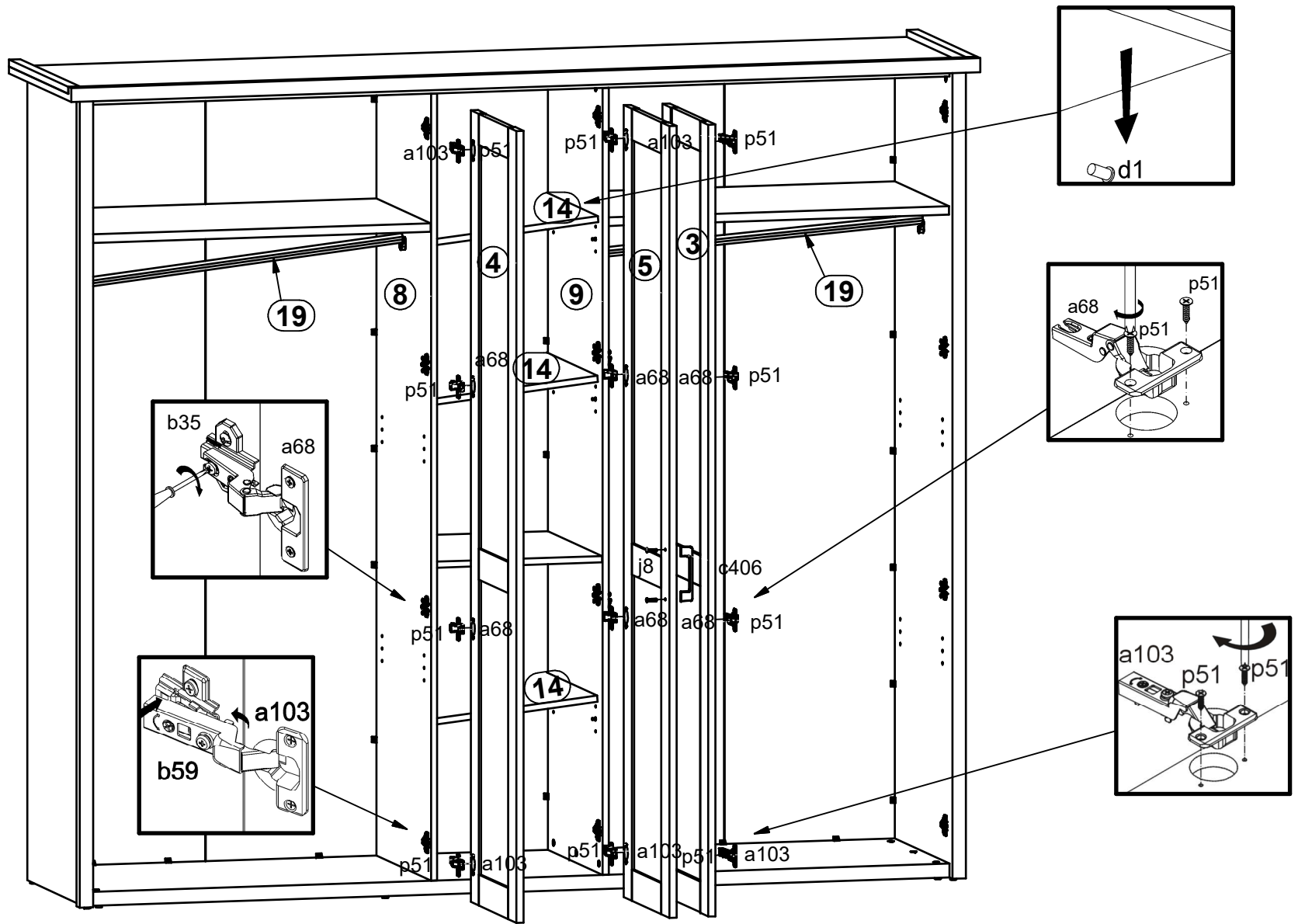

# 10

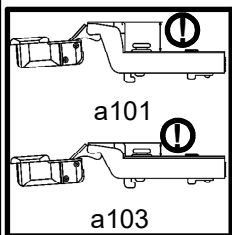
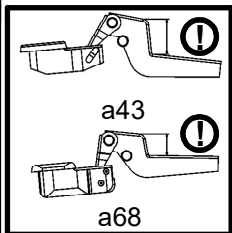
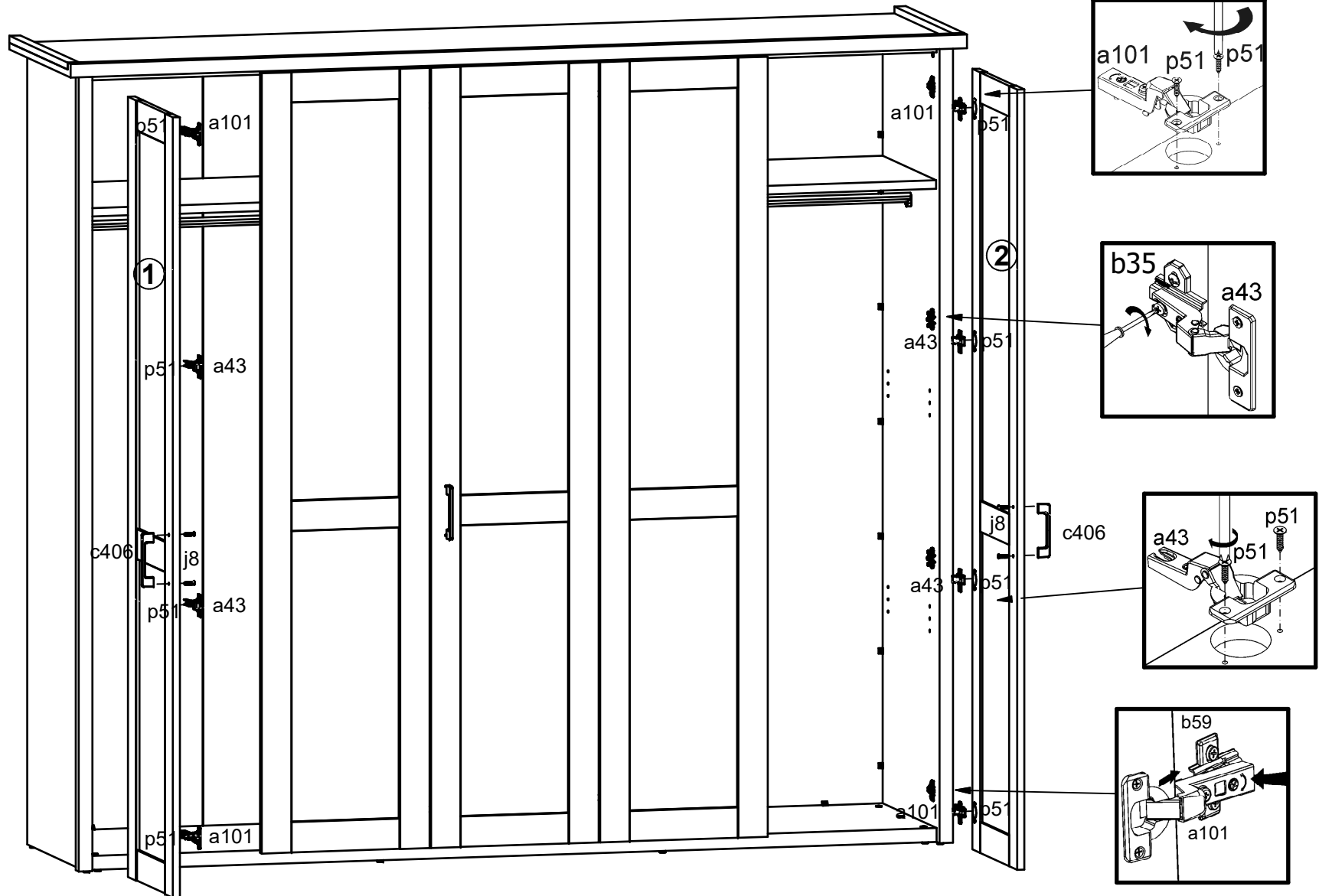

# 11

